

Framery Magazine

06/2023

ISSUE 4 – The 'Get
things done' Issue.

Brought to you by the
world's leading office
booth company.

This is Framery

Framery is the pioneer and world's leading manufacturer of acoustic pods, phone booths and soundproof private spaces for solving noise and privacy issues in offices and other venues.

Our products make employees happier and more productive in the offices of many of the world's leading companies, including Tesla, Puma and Microsoft. In fact, around 70 % of all 'Forbes Top 100' companies use Framery products. In 2022, our revenue was 154 million euros. In the next few years our growth is projected to strongly increase.

We employ around 400 people in 15 countries and our end customers can be found in 89 different countries and across all inhabited continents. Our headquarters is in Tampere, Finland, where around 90 % of us work.

Our product family is made from durable, renewable and recyclable materials and our pods are designed to have a long lifespan. With a strong focus on research and development, as well as a firm commitment to practice what we preach, we remain determined to find the keys to overall work-life happiness – in a sustainable manner.



Contents



Issue 04

06

RESEARCH – CBRE ON CONSTRUCTION

CBRE's global report highlights the benefits of pods over new meeting rooms.

10

PRODUCT HIGHLIGHT – FRAMERY CONNECT

Harness the full power of your pod with analytics.

15

CASE STORY – LOGITECH & MICROSOFT

We joined forces with Logitech & Microsoft to engineer the best hybrid workspaces in the whole wide office.

22

CASE STORY – PIONEERING THE FUTURE OF WORK

The ideal hybrid meeting space at NVIDIA's new office.

26

PRODUCT HIGHLIGHT – FRAMERY CONTACT

Experience face-to-face like never before.

30

DESIGN STORY – EMBRACING AUGUMENTED REALITY

How Augmented Reality played a role in the design of Framery One.



34

INTERVIEW – UNIQUE NORDIC DESIGN

The Uniquely Nordic Design at Supermetrics HQ by Mint & More.

38

RESEARCH – FINDING WORK-LIFE BALANCE

Office workers want perks that improve their work-life satisfaction.

40

SUSTAINABILITY WITH IMPACT

What makes Framery Pods the most sustainable office pods?

44

THE STORY OF FRAMERY

Initially we thought we were selling silence – but we were wrong.

46

FRAMERY PRODUCTS

From one person pods to full-sized meeting rooms

76

PRODUCT SAFETY

Pod safety is always a critical priority.

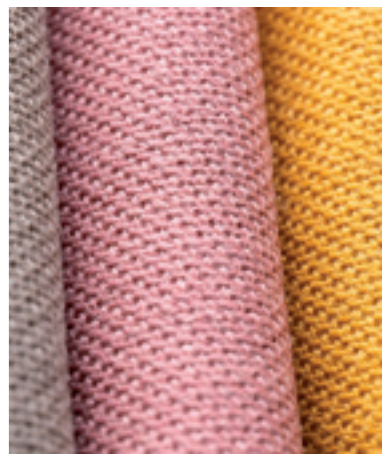

Using office pods instead of constructing new meeting rooms could save the industry over \$30 billion in the USA alone

A recent study found that office pods are more cost-effective than constructing new meeting rooms. This has huge implications for the massive amount of underprepared office spaces across the USA – and could save the industry over 30 billion dollars between now and 2030.

For the second time since 2019, Framery has teamed up with commercial real estate services firm, CBRE Finland, and compared the total costs of one, four and six-person Framery soundproof office pods to the cost of meeting rooms of equal size in Europe, North America and Asia. And, for the second time, the report reveals interesting insights that provide office tenants and managers with

the tools necessary to make informed decisions about the design and layout of their space.

Offices around the world are learning that they are improperly equipped for the needs of a modern workforce. Meetings are shrinking, and 90 % of meetings feature at least one virtual participant. Modern offices are in need of quiet spaces to join calls and host smaller meetings. But properly equipped meeting rooms are in limited supply – especially in the open-plan office spaces that gained popularity in the decades preceding the pandemic. Now companies face a critical investment decision: more walls or pods?



Around the globe, offices are scrambling to keep up with the increased demand for private spaces, as companies are being forced to compete with the perks and amenities provided from the home office.

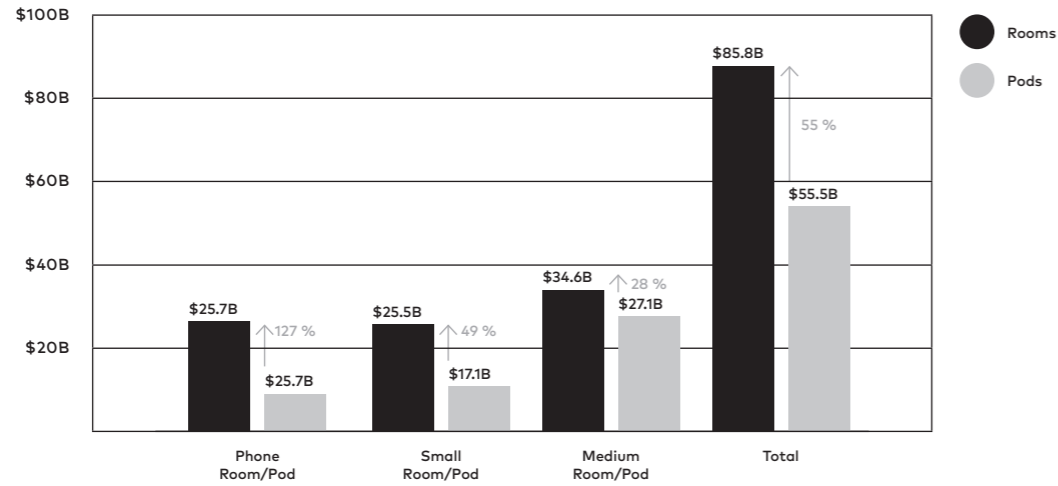

"Office occupiers are investing more and more into flexible spaces and different types of adjustable spaces to meet the demand of flexibility and to attract their workforce back to the office after the pandemic years' remote working," says CBRE's Jussi Niemistö.

Updating office spaces is a costly endeavor. According to the Cushman & Wakefield study, over 41 % of the office field needs to be refurbished in the US alone. That's 2.6 billion square feet of vacant and inadequate office space that "hasn't kept pace with demands to support hybrid working and efficiency priorities."

The cost of building new meeting rooms in that amount of space would surpass \$85 billion.

The same Cushman & Wakefield study also sets the new average number of square feet per office employee 165 sf/person, down from 190 sf/person pre-pandemic. This means you would have 15,700,000 employees using that space. Already pre-pandemic, typical recommended numbers of meeting rooms for open-plan offices were 1 phone room for every 15 employees, one small meeting room for every 20 employees, and one mid-sized meeting room for every 20 employees.

Using calculations based on the 2023 CBRE cost study, the cost of building meeting rooms in the insufficient US office spaces would be 85.8 billion dollars. Pods provide an opportunity to reduce that cost significantly –

the cost of constructed meeting rooms is 55 % higher on average than that of Framery pods. The same amount of private space can be supplied by Framery for roughly 55.5 billion dollars – saving real estate owners and occupiers 30.3 billion dollars throughout the end of the decade.

Office pods are a modular, cost-effective, and more sustainable solution for companies than constructing new meeting rooms. And these are just some of the many benefits office pods can provide, according to Framery CEO

	PHONE ROOM / POD	SMALL ROOM / POD	MEDIUM ROOM / POD
London	+97 %	+25 %	+2 %
Frankfurt	+79 %	+10 %	-5 %
Tokyo	+92 %	+28 %	+18 %
Singapore	+60 %	-2 %	-21 %
New York	+155 %	+63 %	+38 %
San Francisco	+107 %	+45 %	+27 %

The cost of constructed rooms compared to the total end customers cost of comparable Framery pods in different locations. CBRE cost study, 2023.

Samu Hällfors. "As a culture, we are shifting to a more flexible way of working. That is where office pods come in," says Hällfors. "Pods are compact and make better use of existing space. They allow for greater flexibility in rearranging and reconfiguring offices. And they can be moved to a new location when needed. That all greatly reduces the lifetime costs associated with running an office, especially in larger cities with high-priced real estate."

But soundproof pods also benefit the employees – as well as the employer. And employees are beginning to expect this type of office perk from their employer. "One of the most in-demand building offerings is phone

"Meetings are shrinking, and 90 % of meetings feature at least one virtual participant."

	1-PERSON PHONE ROOMS	2-4 PERSON MEETING ROOMS	4+ PERSON HUDDLE ROOMS	TOTAL
Cost of Constructed Rooms	\$25.7 billion	\$25.5 billion	\$34.6 billion	\$85.8 billion
Cost of Framery Pods	\$11.3 billion	\$17.1 billion	\$27.1 billion	\$55.5 billion
Savings w/ Framery Pods	\$14.4 billion	\$8.4 billion	\$7.5 billion	\$30.3 billion

The total cost of constructed rooms or Framery pods needed in the office space requiring renovation in the US by the end of the decade.

booths and private suites, where workers can take phone calls or remote meetings alone or in small groups," states CBRE's Niemistö.

"Today's office requirements and tenant needs frequently show an increase in enclosed private space and more modular space structures. This means focus workspaces for better concentration, but also rooms or phone booths, such as Framery's, for private calls or smaller group meetings that help in creating an office environment that is most effective for the workforce."

Framery invented, manufactured, and sold the world's first office pod, and its Framery O model is now the world's best-selling pod. The majority of Forbes top 100 companies use Framery pods, including Microsoft,

L'Oreal, and Tesla. That adoption rate will only intensify in the next year or two, says Hällfors. "In 2013, the global market for pods was roughly 1,000 units. Now it is tens of thousands of pods. We've seen over 200 manufacturers pop up globally since we created the market in 2010."

CBRE's global research report indicates that access to focus space like pods is now the most desired office perk, ranking higher in employee preferences than a private office. "The increasing demand for these office pods isn't coming so much from management as it is from employees themselves", says Hällfors. "Reimagining the workplace in these innovative, cost-effective ways is what is going to get employees excited to return to the office."

ROOM TYPE	DISTRIBUTION / EMPLOYEES	REQUIRED ACROSS THE US
Phone Room	1 for every 15 Employees	1,046,465
Small Meeting Room	1 for every 20 Employees	784,848
Mid-Size Huddle Room	1 for every 20 Employees	784,848



Analyze
Understand
Optimize
Repeat

Framery Connect is the workplace management tool that gives you valuable insights into how your office works – helping you make better decisions about your office. With detailed statistics for every connected Framery One in your organization you'll be able to harness the full power of your pods.

3 Ways to Make Better Decisions About Your Office



The launch of Framery Connect's Analytics feature marks the next stage of our connected offering to encourage brands to improve usability, make data-driven decisions and develop their understanding of office behaviour.

Following a successful four-month trial with brands around the world, the Public Preview of Analytics marks an industry milestone, as this is the first time a company has combined technology with furniture on such a global scale.

Global brands who trialed Framery Analytics included the likes of H&M, LinkedIn, and Puma, amongst

several others, who are pushing the boundaries of employee-driven office design, how it can benefit and ending the pandemic-induced uncertainty of office design.

Any organization who owns a Framery One can join the Public Preview for free through their Framery Connect account.

Office Insights From Data

Make office development decisions based on behavioral data – so you know how and when people use the office.

Access Analytics Data

Usage data gathered from your connected pods is displayed in visual heatmaps.

Learn How Your Pods Are Used

See hourly pod utilization rates and explore usage over your pod's entire lifetime.

Improve How Your Office Flows

See which spaces are functioning efficiently and learn where your pods should be placed.

Bookable Pods

Make pods bookable by connecting them to your organization's existing calendar – so the entire office stays in sync.

Automated Reservations

Framery One automatically reserves the pod upon entry and displays upcoming bookings on the screen.

Easily Adjust Booking

Extend your reservation directly from the pod through the control panel with a single touch.

Real-Time Availability

Immediate synchronization between your pod and your organization's booking system.



1

2

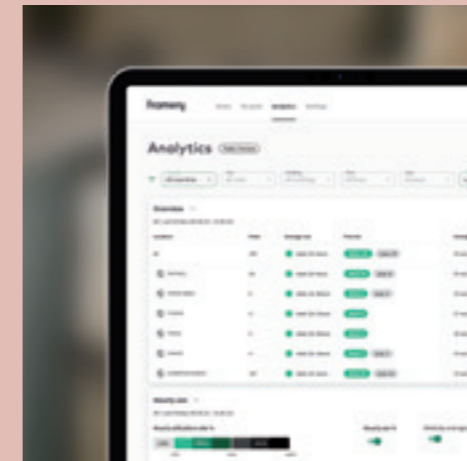

3

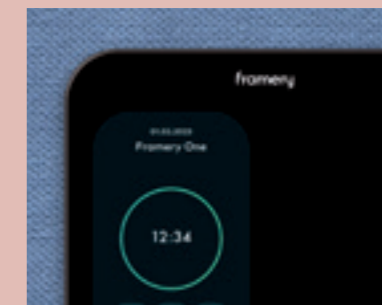

4

- 1 Control your bookings on the fly
- 2 Gain oversight of the usage frequency of all your office pods
- 3 Access real-time data of usage, frequency, activity and overlaps from one clear analytics dashboard.
- 4 Input your personalised settings when entering the pod.



Pioneering the Future of Work

We joined forces with Logitech & Microsoft to engineer the best hybrid workspaces in the whole wide office.

The Future is Flexible. The way the world works has changed. Hybrid work means more and more people are faced with the daily choice of whether to work remotely — or head to the office. This flexibility has created a challenge for many companies who want to keep workers at the office — causing them to compete with the comforts of working from home.

The value of working together at the office isn't lost, as people are willing to forego remote workdays in exchange for their own workspace in the office. But no matter where people choose to do their work, the auton-

omy and flexibility of hybrid work must be addressed in the office. In other words, access to private spaces at work is now more important than ever.

In an effort to accommodate the changing needs of modern work, offices across the globe are scrambling to create modern, flexible spaces in a cost-effective way. This means building or retrofitting spaces for teams to collaborate in, while providing enough private spaces for phone calls, heads-down work, and the onslaught of video conferences taking place throughout the workday.

That's Where We Come In

With so many offices rushing to adapt, we've taken it upon ourselves to help make the office an even more ideal place to work than ever before. We've been doing research to understand the needs of the hybrid workspace, collaborating with partners to create solutions, and putting our ideas to the test.

At Framery, we are experts in creating functional work spaces. Our pods and booths have optimized office spaces across the globe, revolutionizing the way work gets done around the world. Since 2010, we've been on a mission to learn how people use spaces, and what those spaces need in order to be used effectively.

Years of research, engineering, and collaborating with other front-runners in workplace development has solidified our position as industry leaders of soundproof meeting spaces. Hybrid workspaces need to be more than a quiet area to make calls — they must create a symbiotic relationship with the offices they are placed in. That's what makes our products particularly well-suited to hybrid working environments.

The Perfect Hybrid Upgrade

Offices everywhere are recognizing the value of Framery Pods in the hybrid working environment. They're soundproof, versatile, and convenient — making them the ideal solution for focus work and meetings at the office, and a natural choice for upgrading offices.

"Framery pods are incredibly adaptable, lending themselves to an ever-changing workplace," says Lasse

Karvinen, Framery's Head of Products. "They're not just sound-insulated booths — they're thoughtfully designed working spaces that have been engineered to work in tandem with their surroundings."

Framery Pods are cost-effective as well — an additional benefit for facility managers and property owners. "They can easily be reconfigured and relocated without the need for any major interior renovations, making them perfectly suited to adapting and upgrading hybrid offices," says Karvinen.

"They're not just sound-insulated booths — they're thoughtfully designed working spaces that have been engineered to work in tandem with their surroundings"



Countless people around the world use our pods for hybrid work — bringing their own devices and connecting to their virtual meetings. To bring the most value, hybrid workspaces should be functional, flexible, and fully stocked.

Functional

A comfortable and usable working environment

- Guaranteed to provide privacy with two-way sound insulation.
- Supportive of individual work habits and preferences.
- Available when needed, conveniently located, and easy to relocate.

Flexible

An adaptable and modern workspace

- Suited for a variety of uses — from phone calls to meetings and video conferences.
- Designed for individual and team use — both in-person and virtual.
- Accommodating of both scheduled sessions and ad hoc meetings.

Fully stocked

A digitally advanced meeting space

- Supplied with furniture that encourages collaboration and helps get work done.
- Equipped with leading video conferencing hardware that works with the touch of a button.
- Connected to quality video conferencing software and integrated into calendars.





Embracing Hybrid work with Framery

Pairing Framery products with Logitech and Microsoft has resulted in a plug-and-play, all-in-one virtual meeting solution that ensures optimal audio and video quality. Each pod can be equipped with webcams, control panels, and docking stations that improve functionality, and optimize them for hybrid work.

Framery is specialized in acoustic pods — not video conferencing technology. That's why we formed a partnership with Logitech and Microsoft — industry leaders in video conferencing hardware and software — to turn our pods into hybrid working spaces that are ready to use for any purpose.

Working alongside these companies has allowed us to create the best possible solution for hybrid meetings. "We understand that no single company is able to create

"Together, we now have the ability to provide the acoustics for full speech privacy and clear audio as well as the technology needed for high quality telepresence."

the best possible hybrid meeting experience on their own. For that, you need to combine the ideal working space with world-leading video conferencing technology," says Karvinen.

The Perfect Hybrid Partnership

Working together with complementary companies has been crucial to Framery's success throughout the years. This new partnership satisfies the current needs of the workplace industry through a one-stop solution that combines privacy, acoustics, adaptability, and comfort with intuitive, video conference-ready technology. And that's not just a success for Framery — it's a success for our users.

"Our partnership with Logitech and Microsoft equips users with seamless interaction — both in-person and remotely," says Karvinen. "Together, we now have the ability to provide the acoustics for full speech privacy and clear audio as well as the technology needed for high-quality telepresence."

Soundproof Spaces by Framery

A reliable workspace for hybrid

- Work uninterrupted — without interrupting others
- Connect with people both in-person and online
- Focus on the task at hand and get work done

Video Conferencing Hardware by Logitech

The latest technology for superior experience

- Experience superior video and audio quality with Logitech's web & conference cameras
- Join meetings, reserve rooms, and get connected with Logitech's touch controllers
- Eliminate extra cables with Logitech's Logi Dock docking station

Software Solutions by Microsoft

Familiar programs for smoother workdays

- Connect on video calls & virtual meetings via Microsoft Teams
- Integrate seamlessly with calendars via Microsoft Outlook
- Find and reserve pods with Microsoft Outlook's Scheduling Assistant and Room Finder

A New Office & An Empty Canvas

Tech giant NVIDIA has made a name for themselves by tackling technological challenges — in industries from gaming to healthcare to transportation — that otherwise can't be solved.



NVIDIA employs over 20,000 people globally, with more than 50 offices worldwide (with a fleet of over 350 Framery pods globally), and their headquarters in Silicon Valley. A long-time Framery customer, the 2007 Forbes' Company of the Year puts a lot of thought and resources into workplace research and development.

A New Office & An Empty Canvas

NVIDIA's massive Bay Area headquarters are made up of two buildings that combine for over 115,000 m² — separated from each other by a 1.6 hectare garden. The newest addition to their headquarters, a 70,000 m² building named Voyager, features living green walls, a solar panel-lined canopy, a spacious amphitheater, and elevated outdoor "birds nests" where employees can meet to socialize and work.

During the pandemic, NVIDIA, like so many companies around the world, was forced to ask their employees to work from home, leaving their massive new office devoid and empty. Now, as workers begin to repopulate the building, Raymond Chan, NVIDIA's Director of Global Workplace Design & Strategy, expects there to be increased collaboration, vibrancy, and energy at the campus.

A Working Vision Of The Future

Even with the opportunity to work remotely, NVIDIA suspects that employees will want to come back to the office to experience richer interaction with colleagues, and to take advantage of the plentiful amenities. But the company also recognizes that remote work and office work will become more integrated than ever before, as there will always be a number of employees who will join remotely. Always one to explore boundaries, they took the opportunity to create a hybrid working environment to accommodate this new type of work.

NVIDIA's vision for meetings in this new working environment is that of digital equity. Their goal is to create a unified meeting experience — whether you're at the workplace, or joining remotely. And they chose Framery to help create the ultimate hybrid spaces for meeting, collaboration, and co-creation.

An Experimental Comparison

NVIDIA wants to test how their employees choose to do their work in a hybrid office environment. In order to do this, Chan built a competitive scenario to their own solution to explore NVIDIA's "digital equity" concept. They began by removing all video conferencing equipment from meeting rooms, forcing everyone to join virtual meetings from their personal devices. They then set up the ideal

hybrid meeting space by equipping two Framery 2Q Huddle office pods with the Logitech + Microsoft solution.

With the newly-designated hybrid workspaces, NVIDIA's large meeting spaces are now intended to be used mainly for collaboration — a radical change from how they were used in the past. Conference rooms are now to be used for brainstorming and whiteboarding — instead of staring at a large display. They have also dedicated a Framery 2Q Lounge for this type of use — as it's a perfect space for more informal sessions where the best ideas tend to surface.

We still have to wait to learn how these changes will affect the workflow at NVIDIA. With attendance still low, it is still unclear how this way of working and meeting will be received. But the bold initiative by NVIDIA is sure to make waves in their offices across the world.

Staying Flexible

If the past few years has taught us anything, it's that there is no such thing as a "new normal". Companies must be prepared to adapt, pivot, and reshape their understanding if they hope to survive. At Framery, we pride ourselves on our ability to stay flexible, and grow in new directions. That's why partnerships like these are so valuable to our success as a company.

Our work has always been driven by innovative thinking, supported by thorough research, and crafted with great design. But creating the world's first office pod was only the beginning for us. In addition to establishing new partnerships with industry-leading companies, we are exploring and developing our own cutting-edge technologies to digitize the workplace, and futureproof the industry we pioneered.

We revolutionized the workplace with our soundproof solutions for noisy offices. Stay tuned to see what's next.



1



2

- 1 Framery Q pods at the NVIDIA headquarters
- 2 Raymond Chan, NVIDIA's Director of Global Workplace Design & Strategy

Experience
face-to-face

like never
before

Hybrid working is here to stay, but we are lacking interaction. We sit in constant meetings without encounters. We are always connected but lack true contact.

This is why Framery is proud to present a revolutionary product concept that will bridge the gap between the convenience of remote meetings and the personal experience of meeting face-to-face.

The next stage in the race towards a new generation of remote meetings

In the post-pandemic era, a staggering 80–98 % of meetings now feature at least one online participant. Virtual interactions are more common than ever, and while convenient, current video conferencing tools come with many challenges and limitations – the greatest of which is a lack of real face-to-face interaction, the most valuable form of communication. Traditional video calls conceal non-verbal cues, such as eye contact, direct gaze, and body language, thereby limiting personable social dynamics, and even idea generation.

Framery Contact is an innovation that will disrupt offices worldwide and change how we think about remote work for good. The visually and acoustically isolated interior of the pod works in tandem with high-performance projection to bring the human brain to perceive other virtual meeting participants as true to life.

Framery Contact uses a combination of advanced and analogue technology to replicate the true face-to-face meeting experience. Projections are captured, unaltered, and transmitted at the highest possible quality, while strategically-placed mirrors capture and display direct eye contact. This ensures a high degree of social presence and prevents adverse effects caused by computer-generated imagery. Sound is captured with a high-performance cardioid microphone and played out of an active audio monitor that accurately matches the radiation pattern and frequency response of a human speaker. LED lights are optimized to fully illuminate the user without blinding them. The visual and acoustic isolation provided by the pod also help promote spatial presence and connectedness.

The convenience of bringing remote videoconferencing closer to face-to-face meetings also helps companies cut down on unnecessarily costly and environmentally adverse business travel. While a single return flight between London and New York emits 1.7 tonnes of carbon dioxide, the combined manufacturing, use of five years, and recycling of a Framery Contact pod emits only 1.4 tonnes.

Framery Contact will be made available for pilot customers with immediate effect, after which the date of broader commercial availability will be determined. Demo pods will also be available in Framery's showroom in Chicago, and at the Framery headquarters in Tampere, Finland.

Framery Contact is a virtual meeting pod that comes closer to recreating the experience of a real face-to-face conversation than any other technology on the market. It's time to experience face-to-face like never before.

Schedule a product tour
trycontact@frameryacoustics.com

Learn all about it
frameryacoustics.com/contact

DESIGN STORY Embracing Augmented Reality

The Cutting-Edge of Design



At Framery, we love to find new ways to integrate new and exciting technology into our design and engineering process. That's why we partnered up with Varjo Technologies — the makers of the most advanced augmented, virtual and mixed reality headsets for professionals — to streamline the design process of Framery One.

At Framery, we love to find new ways to integrate new and exciting technology into our design and engineering process. That's why we partnered up with Varjo Technologies — the makers of the most advanced augmented, virtual and mixed reality headsets for professionals — to streamline the design process of Framery One.

We used a groundbreaking digital twin workflow that enabled rapidly iterative design on our Framery One in Extended Reality (XR). As a result, we successfully eliminated the need for multiple rounds of expensive and inefficient physical prototyping, and saved an entire month's work of work in the design process.

Technology and the Future of Design

We revolutionized the workplace with the 2021 release of Framery One — the world's first connected pod. In addition to the world-class soundproofing and superior ventilation, Framery One is jam-packed with smart features — such as an integrated touch screen that enables reservation management or control of the internal lighting, airflow, and more.

When it came time to design this new 4G-connected pod, our team of engineers and designers wanted to explore new methods that would help them better understand the user experience. "You can get that perspective that you just cannot with a traditional computer screen," says Miika Hällfors, Framery's Chief Engineer.

Traditional paper mockups and physical prototypes can take between 2–4 weeks between iterations. The Framery design team created rapid prototypes of Framery One in XR — saving not only time and money, but also keeping valuable raw materials from being wasted.

Framery and the Future of Work

As the way people work continues to change around the world, we are constantly looking to change the way we work at Framery — and technology plays a huge role in that change. We are leading the shift towards the future of work by integrating new technologies into our products, and into workplaces everywhere — starting with Framery One and Framery Connect.

Leading that change is Arto Vahvanen, Framery's head of Digital Offerings & Services. "Framery continues shaping the way people work by enhancing our physical

products with digital experiences and by openly exploring new opportunities beyond what we can imagine today," says Vahvanen.

Technology and the Future of Framery

Technology will not only play a huge role in the office of the future — but at Framery as well. That's why we have committed ourselves to discovering, developing, and integrating new digital technologies that will forever change the way the world works.

We are building new software and technology with a new team of developers and software engineers from around the world who are dedicated to exploring and developing the future of work. Because we may not be able to predict exactly what the future holds — but we can take part in shaping it.

"Framery continues shaping the way people work by enhancing our physical products with digital experiences and by openly exploring new opportunities beyond what we can imagine today."



1

The benefits of designing with AR/XR technology

- Reduce the product design cycle by an entire month
- Bypass an entire round of physical prototyping

2



- 1 We used a groundbreaking digital twin workflow that enabled rapidly iterative design on our Framery One in Extended Reality (XR).
- 2 Experiencing the pod interior through AR/XR technology

INTERVIEW Unique Nordic design

Supermetrics HQ by Mint & More

Since 2013, data analytics giant Supermetrics has been growing at an incredible rate. And with over 500.000 users — and customers in over 120 countries — there seems to be no limit to their capacity to scale.

The rapid growth and changing needs of their constantly evolving operations has forced Supermetrics to upgrade their headquarters in Helsinki several times in the past few years. In 2019, they moved into an 800 m² office space in downtown Helsinki, and have since expanded their HQ twice, in 2020 and again in 2022.





How did the company culture at Supermetrics affect your design?

Community plays a big role at Supermetrics. An office where people enjoy spending time encourages teamwork and builds a shared sense of belonging. To improve usage efficiency, we designed the communal office to offer spaces for a variety of uses outside of regular work hours.

What were some of the more interesting needs of this design?

Supermetrics has become renowned for their events and parties. As soon as you walk through the front door you enter a main event space that is built around the heart of their office — the kitchen. We designed their office this way to make you feel welcome.

What was behind the decision to incorporate office pods in your new design?

When we first designed the Supermetrics office, we incorporated a Framery phone booth into the layout. Their positive experiences with Framery led to them wanting more pods. Over time the layouts have adapted with their working habits to fit more pods.

Why did you choose Framery pods for this new space?

Office pods are well-suited to adaptable and iterative spaces. It's important that pods suit the spaces they are in and don't stick out. Framery pods have design options that suited this office's aesthetic. The office is now equipped with 18 total Framery Pods: 5 Framery O, 11 Framery One, 1 Framery Q Meeting Maggie, and 1 Framery 2Q Lounge.



How does the space provide support for Supermetrics?

In addition to being an enjoyable space, an office needs to be functional and support work. We created different types of spaces to make sure that the office is as functional as possible. Our design integrates phone booths, larger team rooms, a studio, the central event space, and even a sauna to bring people together. This is how the office is able to offer flexibility, as well as opportunities for both interaction and privacy.

How did you accommodate Supermetrics' incredible growth rate?

Supermetrics is constantly growing, so expansions are needed. Each expansion requires new solutions and ideas as the company's needs evolve. Teams may switch locations within the office as they grow, and the pods can move with them.

How have the needs of office design changed in the past years?

The bar has been raised. Office environments now compete for employees' time and interest, as people can work from home or on the move. The meaning of culture and interactions has grown in post-covid office design. Enjoyable office environments can attract employees back, as people tend to pick the most pleasant environment available to them.

How have you adapted your design approach as a result?

Our office design focuses on creating an environment that offers comfortable face-to-face interactions and variation to the workday with different types of spaces. But it's not a one-size-fits-all solution either, nor is it solved with gimmicks. Every company's culture and working styles are different, which must be reflected in the design to make a place that truly feels like their home.



The now 1615 m² space was renovated from top to bottom by Mint & More Creative, a bold and bubbly design agency based in Helsinki. The new office offers many luxuries, from soft gradient carpet flooring to a beer tap and wine cooler, and — of course — an impressive fleet of 18 Framery pods.

We talked with Kristian Linnoinen & Roosa Riski, founders of Mint & More Creative, to gain insights into their uniquely Nordic design approach for this project.

What was your mission in the design of this office space?

Our aim was to create a unique and relaxed office space. We wanted to make the space distinctively home-like and comfortable, yet simultaneously bold and intriguing.

How did you achieve your vision?

We went all out to create a park-like atmosphere that blurs the lines between outdoor and indoor space. We achieved this by maximising the flow of natural light, and utilising tree-sized indoor plants, for example.

To read and see more about Mint & More's incredible Supermetrics design story at mintmore.fi/supermetrics2

What do office workers really want?

Companies are eager to get people to return to the office. But the pool tables, beanbags, and ball pit meeting rooms they left behind aren't going to bring them back. In fact, 57% of workers agree that access to privacy is the best office perk.

"Employers are navigating complex challenges to lure their employees back into the office, but have little research or the strategy of what will work."

In the post-lockdown world, companies are trying to lure employees back to the office by offering everything from free lunch to private concerts. But a new survey reveals that employees want yoga studios, office gyms, and designated quiet spaces where they can work in peace – rather than "fun" perks like ping pong tables and gaming consoles.

Through the survey over 4,000 white-collar respondents shared exactly what they want in order to return to the office. The survey findings show that employees are less interested in fun and games during the work day and more hungry for perks that enhance their work-life satisfaction. Key highlights include:

Almost half of all office workers identified fitness perks, such as yoga studios and office gyms (46%), and access to a designated quiet space (44%), as the office perks they want most

Many employees expressed concerns about returning to open-plan offices, with 41% reporting that their ability to concentrate in an open-floor plan office has significantly worsened after the pandemic.

More than one-third (35%) of office workers say that communal games like ping pong and gaming consoles are the least wanted office perk

Nearly half of the office workers are dreading the commute the most as they return to work (44%), followed by office dress codes and communal bathrooms "The findings should put a final nail in the coffin of the ping pong tables, beer kegs, scooters, and other artifacts

of 'mandatory fun' office culture," said Framery's Founder & CEO, Samu Hällfors.

Rather, Hällfors said, the survey findings highlight that after two years of bringing the office into our homes, employees are eager to replicate the best work-from-home perks in the workplace.

"Working from home made it possible for people to exercise more regularly and to do more quality work without the constant interruptions of the open office," says Hällfors. "These are tangible benefits that made employees happier and more productive – and it's clear that they don't want to give them up as they return to the office."

He added: "Employers are navigating complex challenges to lure their employees back into the office, but have little research or the strategy of what will work. We hope these survey results will shed some light on what employees want most when they return."

Methodology

The survey data was collected through the world's largest panel, Cint, in May 2022. In total, 4,044 white-collar respondents from all U.S. states between 18–75 years old answered. For the survey, white-collar occupations meant expert, managerial, or administrative positions.

SUSTAINABILITY with impact

Dedicated to sustainability

At Framery, sustainability is critical to our innovation and strategy work. Our sustainability agenda incorporates Climate and Environment, People and Society, and Fair Business throughout our operations and across our entire value chain.

- 1 Materials swatches
- 2 Team collaboration at Framery HQ
- 3 Locally sourced Finnish pine trees

1



2



3

Human rights are also fully integrated into everything we do. Since 2018, Framery has been committed to the United Nations Global Compact (UNGC) corporate responsibility initiative and its principles. Our ambition is to make three million people happier by providing our

Pods and phone booths to workplaces, schools, hospitals and other spaces. And we constantly seek to make our environmental footprint smaller and handprint bigger to be sure we are not just creating happiness today, but happiness also for future generations.



1

The three themes of our sustainability work

1. Fair Business

Over the last five years, Framery has grown organically from EUR 1 million to over EUR 100 million. What's our secret to sustainable growth? Well, simply, we don't engage in any funny business. We pay our taxes fair and square; we do honest deals with our partners and dealers; we pay fair wages and we offer our customers the best possible product. Furthermore, we have continued to keep all our production at our Tampere headquarters in Finland. This way, we can support our local community by offering jobs in our home municipality of Pirkanmaa.

2. People & Society

We take special care of our employees, customers and all the people we work with. We have a strong culture backing up our sky-rocket growth and the happiness of our people. We invest in our people, because we believe that happy Framerians make the best possible products and provide

our customers with the best service—in turn making them happy as well. While there are great cultures in many companies, our unique way of working makes Framery a one-of-a-kind. Our values in the core of our culture are the abilities and practices that we especially appreciate in each other and where we base our decision making on. They are not just hollow phrases – our values create our shared practices, rules and goals. When we recruit new colleagues, consider pay raises or individual growth, we always mirror the actions of the individual to our values.

OUR VALUES

- Respect
- Courage and Curiosity
- Transparency
- Responsibility
- Good judgment

At Framery we have absolutely zero tolerance for discrimination and inappropriate behavior. We cherish and support different viewpoints and believe that the more diverse spectrum of different views we have, the better decisions we are able to make.

3. Climate and Environment

We have not lose sight of the existential environmental threats facing us globally, from resource scarcity and climate change to loss of biodiversity. These unprecedented events continue to strongly motivate us at Framery to strive to do our part towards helping to create a far more sustainable future world.

The shift towards a circular economy is indispensable. By converting our business models to be more circular, we are future-proofing our business and respecting planetary boundaries at the same time. Framery has paid special attention to better understand its position in circular economy and climate change.

Framery is committed to the Science Based Targets as it relates to reducing greenhouse gas emissions. This target shows Framery's commitment to the latest climate science that says it is necessary to meet the goals of the Paris Agreement—to limit global warming to well-below 2°C above pre-industrial levels and pursue efforts to limit warming to 1.5°C.

2



ECO-EFFICIENT OFFERING

- Our products have GREENGUARD certification
- Raw materials are listed transparently in Health Product Declarations (HPD's) on 100 ppm level
- All wood component suppliers are required to have FSC or PEFC certification. Fabrics have EU Ecolabel.
- Felts and acoustic foam are ca. 80 % recycled PET (plastic bottles). Steel is ca. 20 % recycled and glass 15 %.
- Framery provides externally verified product life cycle carbon footprint and other environmental impacts in Environmental Product Declarations EPD's.
- Our goal is to produce products that have as long-life cycle as possible.
- This goal is supported by timeless design and durable high-quality materials. (None of our products have come to the end of their life cycle yet according to our knowledge).
- We use renewable and recycled raw materials.
- Our own production material efficiency rate was 94 % in 2020.
- Virtually no waste goes to landfill.
- We use 100 % renewable electricity and our milk run logistics is 100 % biogas operated.
- Service and spare parts are available.
- Our products can be relocated and reused.
- Our products are recyclable and recycling instructions are available. We are pioneering a 'pod as a service' circular business model in Finland, Sweden, Norway, Germany, Netherlands and France, called Framery Subscribed. The same pod can be used from one customer to another enabling multiple life cycles and saving valuable resources.

- 1 Framery pods are produced in Tampere, Finland using 100 % renewable electricity
- 2 Framery pods are designed to be durable and timeless

"Buy me a phone booth"

It was 2010 and there were around a hundred employees working in the same open office space, two of them, including our current CEO who was also one of Framery's founders, had enough of listening to their boss speaking constantly on his phone with a headset. It was basically impossible to concentrate on anything. The two soon came up with a less than polite proposal, that the boss go elsewhere to make his calls. He was quick with a response: "Well, buy me a phone booth". The problem being that there wasn't one on the market so the only alternative was to make one.

That day they gave up working for that software company and started to become experts on acoustics and, Framery was born. The first booth was ugly and not particularly soundproof, but the guys had found their calling and realized that many workplaces suffer from the same problem with no solution available.

After years of development, analyzing customer feedback and rigorous trial and error, our sixth generation for phone booth or pod, the Framery O, turned out to be super functional, a silent place to work with superb acoustics and silent ventilation. Initially, as with anything new it was a struggle to sell them, but when people began to use them and their office culture quickly transformed, news began to travel and soon companies such as Microsoft, SAP and Deloitte bought them and loved them. We sold them in their thousands, and today the Framery O is the world's best selling pod.

Initially we thought we were selling silence – but we were wrong. Together with our customers we saw the bigger picture. In open offices there are constant disruptions from phone calls, ad hoc meetings and discussions. It's hard to recover your concentration when it's broken, it takes time to refocus, you become less productive, less creative and your potential is not fulfilled. At the same people need spaces where they can connect, discuss and collaborate. In short, people need to be able to focus on what really matters.

"That day they gave up working for that software company and started to become experts on acoustics, and Framery was born."

This quickly became our mission: To empower people at work to get things done and focus on what really matters: solving problems, creating solutions, building a better tomorrow.

Work and the way we do it is changing quickly. What was relevant in an industrial context does not apply to information work. What worked in an open-plan office does not work in multipurpose spaces. And whatever we are learning about new digital working methods, will become obsolete as soon as we start working side-by-side with artificial intelligence. So noise reduction is, and will be, just a part of the solution.

With a strong focus and investment in research, and a commitment to practice what we preach inside our own company, we are determined to continue providing tools and solutions for a successful workday.

PART TWO Meet the fleet

Products

Framery is the pioneer of soundproof office pods and workspaces. Every detail of every product is carefully considered and perfected to ensure people can focus on what really matters and get things done.



Framery One

Framery One sets a new industry standard for what a soundproof pod is capable of. Optimized for video and designed for focus work, Framery one is a highly adaptable workspace packed with technology to help the entire office work better. This soundproof office pod features leading sound insulation and ventilation, and echo-free acoustics to let you focus on your work and connect online with people anywhere.

Framery One – The world's most advanced soundproof office pod

Stunning design and world-class soundproofing make Framery One the ultimate one-person workstation. This pod is engineered for focus work or video calls and is compatible with Framery Connect. Framery One comes equipped with dual-embedded lighting optimized for video, adjustable ventilation & lighting and a height-adjustable table.



Framery One

The core essential features of the ultimate soundproof workstation.

- Space for standing work or to add your own stool
- Additional upgrades available



Framery One Premium

Get even more out of your Framery One with the premium package.

- Height-adjustable seat
- Dual footrests
- Activated carbon filter
- Fully-customizable materials & finishes

Framery One / Furniture



HEIGHT-ADJUSTABLE TABLE provides comfort for all users. The table can be adjusted vertically between 74–116 cm / 29.1–45.7 in. The ample surface of the table (76.5 cm width & 46 cm depth/ 30.1 & 18 in) provides space for laptops, personal devices and other work tools.

HEIGHT-ADJUSTABLE SEAT has two footrests for comfortable working. The height can be adjusted vertically between 59–85 cm / 23.2–33.5 in.

Framery One / Colors

EXTERIOR

	White (Standard) RAL 9016 Ultramatt
	Black (Standard) RAL 9005 Ultramatt
	Gray (Standard) S7500 - N Ultramatt
	Navy S 7020 - R90B Ultramatt
	Sand S 2010 - Y20R Ultramatt
	Powder Blue 3421-R86B Ultramatt
	Winter Moss S 7010-G10Y Ultramatt
	Blush 2728-R01B Ultramatt

INTERIOR

	Pure Gray (Standard) Tonal #60123 Gabriel
	Navy Atlantic #66057 Gabriel
	Sand Tonal #61180 Gabriel
	Rouge Tonal #64210 Gabriel

CARPET

	Light Gray (Standard) Ex-dono Quartet #393330 Fletco carpet
	Dark Blue Zenith #T371880
	Champagne Zenith #T371210 Fletco carpet
	Grape Zenith #371680 Fletco carpet

TABLE

	White (Standard) White laminate
	Black Black Laminate with anti-fingerprint surface
	Oak veneer

SEATING FABRIC

	Graphite (Standard) Select #60051 Gabriel
	Dark Blue Select #66144 Gabriel
	Grape Select #61190 Gabriel
	Rose Select #65117 Gabriel
	Powder Blue Select #67098 Gabriel
	Beige Select #61184 Gabriel
	Green Selected #68209 Gabriel
	Mustard Select #62098 Gabriel

Framery One / Functionalities

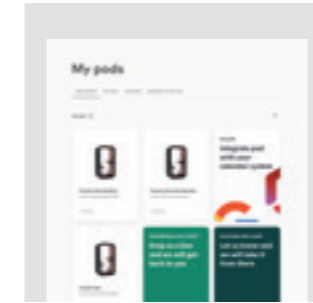

FRAMERY CONNECT is a revolutionary digital service that brings more functionality to Framery One pods. Framery Connect activates your Framery One, enables calendar connectivity, and gives you valuable insights into how your office works. With Framery Connect, your Framery One can be easily reserved through Google and Microsoft calendars. Framery One automatically creates a calendar reservation upon entry, which can be extended through the pod's UI Panel. And analytics data helps you see how and when your Framery One pods are used, and where they should be placed to optimize your office.



UI PANEL allows you to adjust the pod's lighting and ventilation according to your personal preferences. Choose from Work Mode or Video Mode lighting presets, or control the brightness of both lights individually. The integrated 4G module enables to see the pod's availability, and make reservations directly with the Bookable Pods functionality on the touchscreen. Charge your devices via power outlets (1 power socket, USB C socket, optional LAN) located on the UI Panel.



VIDEO CONFERENCE LIGHT is a dimmable LED panel embedded into the tech wall of Framery One improves the experience of video calls. Warm light is cast on the user's face in a wide spread with excellent color rendering capacity (90CRI), providing excellent illumination without bothering the user. The 4000K color temperature guarantees a natural look and feel with optimal user comfort. Adjustments to both the video conference light and the ceiling light can be made easily via the UI Panel.



OCCUPANCY LIGHT displays a red light with 360° visibility when stepping into your Framery One, to let the office know the pod is in use.

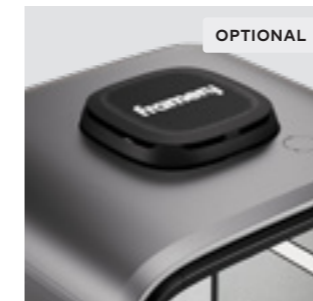

ACTIVATED CARBON FILTER keeps the air inside Framery One extra fresh and clean and free of odors with an activated carbon filter. The filter removes pollutants from the air with an adsorption process.

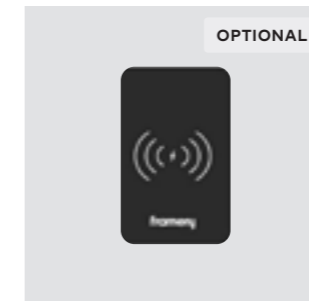

WIRELESS CHARGER allows you to charge your phone fast and wire-free inside our pods. The charger itself is located underneath the table, with a sticker on top of the table indicating where to place your phone to get it charged.

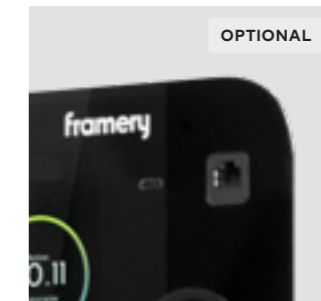

LAN PORT is possible to add to the UI Panel. This option includes a LAN cable.



MOVABILITY KIT allows you to easily relocate your Framery One without disassembly by lifting the levelling feet up and thus lowering the pod onto its wheels. The high load capacity polyurethane castor wheels are both durable and pliable. Number of wheels: 4.

PRODUCTS Meet our fleet

Framery O

Framery O is the ideal space to take ad-hoc phone calls and join video meetings without disturbing the office. Featuring world-class soundproofing and echo-free acoustics, you can comfortably talk in private without compromising sound quality. And automatic ventilation makes Framery O a comfortable working environment for one.

Framery O – The original soundproof office phone booth



Framery O Quick Call

The Quick Call Package includes the basic features of a single-person pod that are needed for having a private phone call without disturbing your colleagues. In addition to superior sound insulation, it has a white high-pressure laminated table, acoustic interior felt, anti-static carpet, occupancy sensor, LED lighting and power outlet. Seat not included.



Framery O Standard

The Standard Package expands the use of a single-person pod to also include heads-down work. In addition to the core features of Framery O, it includes a fixed height-adjustable Tovi stool and power source with USB-C+A outlets.

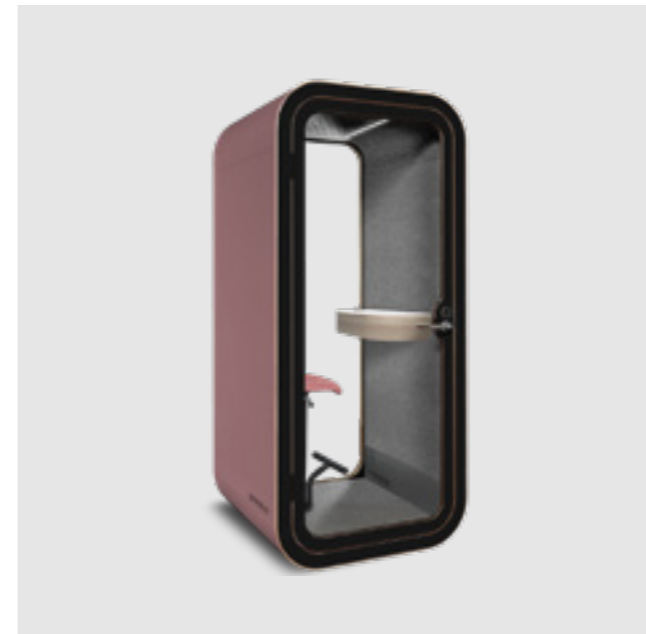

Framery O Color

The Color Package lets you select from all of the color options available for Framery O – making it an affordable way to fully personalize the pod. Select the color of the table, seat fabric, exterior covers, door and door frame.

Framery O / Furniture



HEIGHT-ADJUSTABLE SEAT ensures that the stool accommodates all users. The height can be adjusted vertically between 68.5–81.5 cm / 26.8–31.9 in. The stool is attached to the pod with a robust fixing plate making it stable and durable. The color of the seat can be customized.



REGULAR TABLE is designed to provide space for a laptop, a notebook and a mobile charging your devices while working or taking part in a call. Table size: 13 x 70 x 28.5 cm / 5.1 x 27.5 x 11.2 in (height, width, depth). Table height from floor: 102.5 cm / 39.6 in.



WIDE TABLE is designed to provide space for a laptop, a notebook and a mobile charging your devices while working or taking part in a call. Table size: 12 x 75 x 30 cm / 4.7 x 29.5 x 11.8 in (height, width, depth). Table height from floor: 102.5 cm / 39.6 in.

Framery O / Colors

EXTERIOR

-  White (Standard)
RAL 9016 Glossy
-  White
RAL 9016 Ultramatt
-  Black
RAL 9005 Ultramatt
-  Gray
S7500-N Ultramatt
-  Navy
S 7020 - R90B Ultramatt
-  Sand
S 2010 - Y20R Ultramatt
-  Powder Blue
3421-R86B Ultramatt
-  Winter Moss
S 7010-G10Y Ultramatt
-  Blush
2728-R01B Ultramatt



INTERIOR

-  Light Gray Felt (Standard)

CARPET

-  Light Gray (Standard)
Ex-dono Quartet #393330
Fletco Carpets











FRAME

-  White (Standard)
F6463 Formica
-  Black
F2253 Formica

TABLE

-  White (Standard)
White laminate
-  Black
Black Laminate with
anti-fingerprint surface

SEATING FABRIC

-  Light Gray (Standard)
Remix 3 #123 Kvadrat
-  Grape
Select #61190 Gabriel
-  Rose
Select #65117 Gabriel
-  Green
Selected #68209 Gabriel
-  Antimicrobial Highland
Graphite 954 Panaz
-  Graphite
Select #60051 Gabriel
-  Dark Blue
Select #66144 Gabriel
-  Powder Blue
Select #67098 Gabriel
-  Beige
Select #61184 Gabriel
-  Mustard
Select #62098 Gabriel

Framery O / Optional Functionalities



COPPER-PLATED DOOR HANDLE helps to prevent the spread of viruses. According to a study by Centers for Disease Control and Prevention (CDC), viruses disintegrate quicker after landing on copper surfaces than on plastic or stainless steel surfaces.

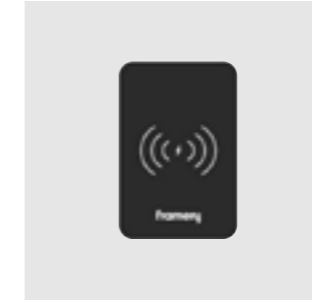

WIRELESS CHARGER allows you to charge your phone fast and wire-free inside our pods. The charger itself is located underneath the table, with a sticker on top of the table indicating where to place your phone to charge. Available for Wide table.



POWER OPTIONS includes outlets with or without two charging USB-C+A sockets and a LAN cable lead-through.



MOVABILITY KIT allows you to easily relocate your Framery O without disassembly. This kit includes six castors to make it easier to move the pod.



SELF-CLOSING HINGES can be used to limit the opening of doors and to make sure that they are not blocking passageways. Available in black and white.



SMART LOCK COMPATIBLE is a kit of parts that allows selected smart locks and key locks to be installed in Framery O.



ELECTROMECHANICAL CODE LOCK handle can be used to limit access to a pod only for users with a number code.



LAN CABLE 7 m.

Framery Q

Framery Q office pod is a multifunctional, soundproof space for 1-4 people. This pod is ideal for meetings, brainstorming sessions, and important one-on-one conversations in private without disturbing the office – or the office disturbing you. The pod's award-winning design takes a minimum amount of floorspace, fitting seamlessly into your office.

Framery Q – The soundproof meeting pod for 1-4 people



Framery Q Meeting Maggie

Suitable for meetings, brainstorming, gathering face-to-face, getting work done, and much more. Meeting Maggie comes with pleasant LED lighting and two power sockets. Two Maggie sofas with curved or straight backrest and a turnable table are always included.



Framery Q Meeting Maggie Premium

This soundproof, hybrid meeting space can be used by 1-4 people, both in-person and online. A screen bracket and turnable monitor arm makes the layout ideal for videoconferencing, and adjustable lighting & ventilation makes the meeting experience even better. Two Maggie Sofas are always included, and you can choose between curved or straight backrest.



Framery Q Flip n' Fold

The Framery Q Flip n' Fold is a convenient and flexible fully-accessible interior meeting space. Easily accessible with a wheelchair, the low doorstep, automatic door opener, and folding chairs and table enable many different meeting arrangements. Automatic air ventilation creates a fresh and comfortable working environment. The product is easy to assemble and relocate when necessary.



Framery Q Flow

The Framery Q Flow interior layout is designed for uninterrupted heads-down work. It comes with an adjustable electric table that allows you to change your working position from sit-to-stand in a matter of seconds. The Flow has plenty of space inside for a chair and even an extra stool, making it possible to invite your colleague in for a chat or a shared video conference.

Framery Q / Furniture



MAGGIE SOFAS are available with different backrest configurations and with or without armrests. Framery Q Meeting Maggie has two Maggie sofas.

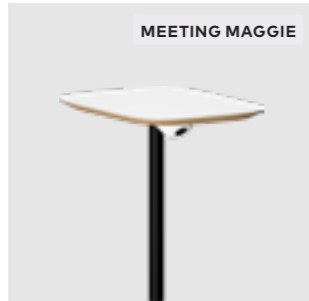

TURNABLE TABLE allows something to be shown from a laptop and leaves room for entering and exiting the pod. Framery Q Meeting Maggie comes with a turnable table.



FOLDABLE SEATS AND TABLE for maximum accessibility. Four foldable seats are included in the Framery Q Flip n' Fold pod, together with a foldable table.

Framery Q / Colors

EXTERIOR

-  White (Standard)
RAL 9016 Glossy
-  White
RAL 9016 Ultramatt
-  Black
RAL 9005 Ultramatt
-  Gray
S7500-N Ultramatt
-  Navy
S 7020 - R90B Ultramatt
-  Sand
S 2010 - Y20R Ultramatt
-  Powder Blue
3421-R86B Ultramatt
-  Winter Moss
S 7010-G10Y Ultramatt
-  Blush
2728-R01B Ultramatt



INTERIOR

-  Light Gray Felt (Standard)



CARPET

-  Light Gray (Standard)
Ex-dono Quartet #393330
Fletco Carpets











FRAME

-  White (Standard)
F6463 Formica
-  Black
F2253 Formica

TABLE

-  White (Standard)
White laminate
-  Black
Black Laminate with
anti-fingerprint surface

SEATING FABRIC

-  Maggie Gray (Standard)
Canvas #154 Kvadrat
-  Grape
Select #61190 Gabriel
-  Rose
Select #65117 Gabriel
-  Green
Selected #68209 Gabriel
-  Antimicrobial Highland
Graphite 954 Panaz
-  Graphite
Select #60051 Gabriel
-  Dark Blue
Select #66144 Gabriel
-  Powder Blue
Select #67098 Gabriel
-  Beige
Select #61184 Gabriel
-  Mustard
Select #62098 Gabriel

Framery Q / Optional Functionalities



SCREEN BRACKET is in the center of the back glass and can be fitted with a maximum 27" display with VESA 75 X 75 or 100 X 100 mounting. Compatible with Framery Q Meeting Maggie. By having a screen bracket you can extend the use cases within the pod being able to use display for presentations / hybrid meetings. Option includes screen bracket, display acquired by the customer.



TURNABLE MONITOR ARM allows two users to sit on one side of a Framery, turn display towards them, and both be visible on a camera mounted on it. Compatible with Framery Q Meeting Maggie. Screen bracket is included when selecting turnable monitor arm as an option. Display and camera acquired by the customer.



CONTROL PANEL allows you to adjust ventilation and lighting inside the pod. Compatible with Framery Q Meeting Maggie and Flow. Control panel is a useful option as use cases within larger pods may vary. It is installed on doorwall frame. Option includes the control panel and required wires.



BOOKING BRACKET is a universal booking tablet bracket with a plywood surface attached to the door locking plate. Two sizes available to fit your device. Option includes the bracket and kit required for attachment. Customer acquires the booking tablet and cover for it which is mounted to the bracket. Bracket dimensions: Small 12 x 23 cm / 4.7 x 9.1 in. Large 22 x 30 cm / 8.7 x 11.8 in.

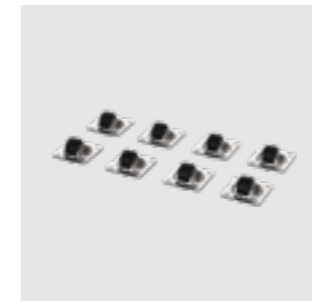

MOVABILITY KIT allows you to easily relocate your Framery Q without disassembly. Option includes eight castors and fasteners that can be installed to the bottom of the pod. Compatible with Framery Q Meeting Maggie and Flow.



SELF-CLOSING HINGES can be used to make sure the door is not blocking passageways. Available for both left-handed and right-handed door. Option includes set of black hinges for the door. Compatible with Framery Q Meeting Maggie and Flow.

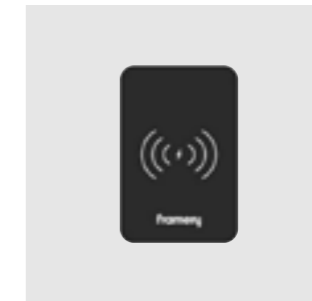

WIRELESS CHARGER allows you to charge your phone wire-free inside your pod. The charger itself is located underneath the table, with a sticker on top of the table indicating where to place your phone to get it charged. Option includes the charger, required wires and the sticker. Compatible with Framery Q Meeting Maggie and Flow.



DATA CARTRIDGE FOR POWER OUTLET Power outlet has two power and one USB (C+A) sockets as standard. Data cartridge is attached during installation to power outlet located underneath the table. Option includes a data cartridge with two LAN ports and two LAN cables. Compatible with Framery Q Meeting Maggie and Flow.



SMART LOCK COMPATIBLE is a kit of parts that allows selected smart locks and key locks to be installed in Framery Q. Option includes kit shown in picture. Smart lock itself is acquired by the customer. Compatible with Framery Q Meeting Maggie and Flow.



COPPER-PLATED DOOR HANDLE helps to prevent the spread of viruses. According to a study by Centers for Disease Control and Prevention (CDC), viruses disintegrate quicker after landing on copper surfaces than on plastic or stainless steel surfaces. Option includes copper-plated door handle. Compatible with Framery Q Meeting Maggie and Flow.



ANTI-MICROBIAL POLYESTER FABRIC is an anti-microbial, waterproof, bleach cleanable, stain resistant and durable polyester fabric. Our non-toxic material is safe and ISO 10993-5:2009 tested. Compatible with Framery Q Meeting Maggie.

Framery 2Q



Framery 2Q is designed for 4–6 people. This meeting pod is the ideal place to co-create, brainstorm and meet together. Framery's superior sound insulation and echo-free acoustics ensure that your meetings won't disturb the office – and the office noise won't disturb you.

Framery 2Q – The soundproof meeting room for teams of up to 6



Framery 2Q Huddle

Framery 2Q Huddle is the ideal setup for meetings - whether attendees are present, joining remotely, or anything in between. Gather your team around the table where everyone fits comfortably - even with their laptops. The spacious pod allows everyone to move around freely, and bring additional seating if needed.



Framery 2Q Lounge

Framery 2Q Lounge interior layout provides a more casual environment. It's perfect for relaxed company meetings, a calm space to retreat to during the workday, or an area for socialization. Custom-designed Clint Sofa, large whiteboard, free-standing Piaggio table and a wall shelf create a functional yet relaxed setting.



Framery 2Q without furniture

Choose the Framery 2Q meeting pod without furniture to furnish it the way you like. The superb sound insulation ensures you and your team total sound privacy and the adjustable airflow keeps the atmosphere fresh. A low doorstep makes the Framery 2Q wheelchair accessible.

Framery 2Q / Furniture



HUDDLE



LOUNGE

FRAMERY 2Q HUDDLE comes with standard (72 cm / 28.3 in) or high table (110 cm / 43.3 in). Gather your team of four around a spacious table where everyone fits comfortably, laptops included. There is enough space for overflow seating if more team mates drop by.

FRAMERY 2Q LOUNGE comes with custom-designed Clint Sofa, large whiteboard, free-standing Piaggio table and a wall shelf which were designed to create a functional yet relaxed setting for meetings and brainstorming sessions.

Framery 2Q / Colors

EXTERIOR

-  White (Standard)
RAL 9016 Glossy
-  White
RAL 9016 Ultramatt
-  Black
RAL 9005 Ultramatt
-  Gray
S7500-N Ultramatt
-  Navy
S 7020 - R90B Ultramatt
-  Sand
S 2010 - Y20R Ultramatt
-  Powder Blue
3421-R86B Ultramatt
-  Winter Moss
S 7010-G10Y Ultramatt
-  Blush
2728-R01B Ultramatt

INTERIOR

-  Light Gray Felt (Standard)

CARPET

-  Light Gray (Standard)
Ex-dono Quartet #393330
Fletco Carpets











FRAME

-  White (Standard)
F6463 Formica
-  Black
F2253 Formica

TABLE

-  White (Standard)
White laminate

SEATING FABRIC

-  Clint Gray (Standard)
Fiord 2 #151 Kvadrat
-  Clint Lemon (Standard)
Steelcut Trio
-  Grape
Select #61190 Gabriel
-  Rose
Select #65117 Gabriel
-  Green
Selected #68209 Gabriel
-  Antimicrobial Highland
Graphite 954 Panaz
-  Graphite
Select #60051 Gabriel
-  Dark Blue
Select #66144 Gabriel
-  Powder Blue
Select #67098 Gabriel
-  Beige
Select #61184 Gabriel
-  Mustard
Select #62098 Gabriel

Framery 2Q / Functionalities



CONTROL PANEL allows you to adjust ventilation and lighting inside the pod. It is a standard functionality included with all Framery 2Q configurations. For Framery 2Q Huddle and Lounge the control panel is installed on doorway frame; In Framery 2Q Without Furniture the control panel is in the middle column next to back glass.



SELF-CLOSING HINGES are used to make sure the door is not blocking passageways. Available for left-handed door. Includes set of black hinges for the door. Self-closing hinges are included as standard on all Framery 2Q configurations.



SCREEN BRACKET is located on the table wall. It is possible also to mount the bracket on the opposite wall. Option includes mounting plate for the wall, and mounting plate for the screen. Included in Framery 2Q Huddle. As an option, compatible with Framery 2Q Lounge and Without Furniture. Screen is not included.



POWER OUTLETS IN HUDDLE are installed as peak socket on Huddle table. It includes four power sockets, USB (C+A) and a HDMI socket. Additionally, two power sockets under the table. Optional LAN ports are available (replaces one of the power sockets). Included in Framery 2Q Huddle.

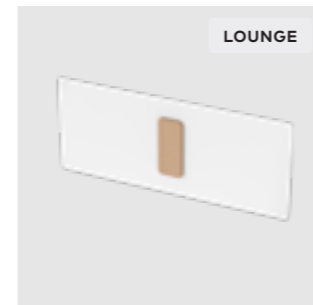

WHITEBOARD is attached to either side of the non-glass walls. Dimensions of the whiteboard are 100 x 240 cm / 39.4 x 93.6 in (height, width). Option includes the whiteboard and the cork center. Included in Framery 2Q Lounge. Compatible also with Framery 2Q Huddle and Without Furniture.



PIAGGIO TABLE is a movable table with tabletop dimensions of 36 x 42 cm / 14.1 x 16.5 in. Table height: 62 / 24.4 in. One Piaggio table is included in Framery 2Q Lounge. As an option, additional tables can be selected. Compatible also with Framery 2Q Without Furniture.

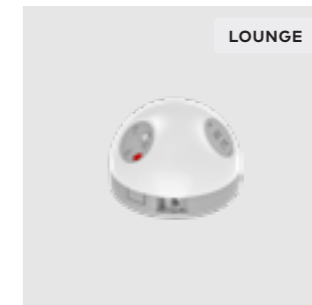

POWER OUTLETS IN LOUNGE are located under the lounge shelf table and the sofa. There are six power and two charging USB (C+A) sockets. Optional LAN ports are available. Included in Framery 2Q Lounge.



BOOKING BRACKET is a universal booking tablet bracket with a plywood surface attached to the door locking plate. Two sizes available to fit your device. Option includes the bracket and kit required for attachment. Customer acquires the booking tablet and cover for it which is mounted to the bracket. Bracket dimensions: Small 12 x 23 cm / 4.7 x 9.1 in. Large 22 x 30 cm / 8.7 x 11.8 in. Compatible with all Framery 2Q configurations.



SMART LOCK COMPATIBLE is a kit of parts that allows customer selected smart lock and key to be installed. Option includes kit shown in picture. Smart lock itself is acquired by the customer. Compatible with all configurations of Framery 2Q.

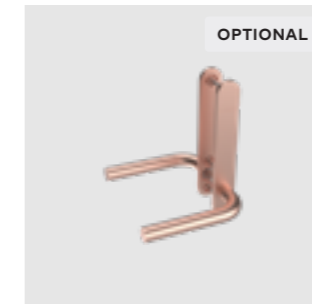

COPPER-PLATED DOOR HANDLE helps to prevent the spread of viruses. According to a study by Centers for Disease Control and Prevention (CDC), viruses disintegrate quicker after landing on copper surfaces than on plastic or stainless steel surfaces. Option includes copper-plated door handle. Compatible with all configurations of Framery 2Q.

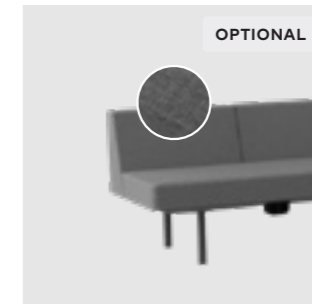

ANTI-MICROBIAL POLYESTER FABRIC is an anti-microbial, waterproof, bleach cleanable, stain resistant and durable polyester fabric. Our non-toxic material is safe and ISO 10993-5:2009 tested. Compatible with all configurations of Framery 2Q.

Technical specifications

66

FRAMERY ONE

The world's most advanced soundproof office pod

67

FRAMERY O

The original soundproof office phone booth

68

FRAMERY Q

The soundproof meeting pod for 1–4 people

72

FRAMERY 2Q

The soundproof meeting room for teams of up to 6

Framery One

TECHNICAL SPECIFICATIONS

Size	EXTERIOR 225.5 × 122 × 100 cm / 88.8 × 48 × 39.4 in (h, w, d). With castors (comes with movability kit): extra 3 cm / 1.18 in in height. With activated carbon filter: extra 6.5 cm / 2.56 in in height. INTERIOR 204 × 102 × 93 cm / 80.3 × 40.15 × 36.6 in (h, w, d). DOORWAY 204 × 101.5 cm / 80.3 × 40 in (h, w).
Weight	357 kg / 787 lb.
Ventilation Space	Minimum recommended space for air to circulate. Above: 15 cm / 5.9 in. (No extra space needed on top of the filter housing.)
Acoustics	> 30 dB (Speech level reduction according to ISO 23351-1 testing method).
Airflow	Total airflow is 29l/s, 61 CFM (103.6 m³/h) On standby mode the fans are working on 25 % of the maximum power.
Lighting	CEILING LIGHT color temperature 4000K, illuminance up to 500lux on the tabletop. VIDEO CONFERENCE LIGHT color temperature 4000K, illuminance up to 400lux on the user's facial area.
Exterior materials	EXTERIOR Powder coated deep-drawn steel panels. GLASS Sound control laminated glass (4 + 4mm / 0.16 + 0.16 in). FRAME Matt black frames made from steel & aluminum.
Interior materials	SOLID WALLS AND ROOF A sandwich element chassis, made of deep-drawn sheet metal & recycled acoustic foam. Replaceable interior panels made from PET sheets which are laminated with polyester fabric. FLOOR Anti-static and stain resistant low loop pile carpet. TABLE Formica laminate on birch plywood with varnish trim.
	Power cord can be led out of the bottom corner of the pod or from the roof. The cord length outside the pods is 4.5 m / 177.6 in. The door handedness can be changed on-demand with simple tools, by flipping the front frame in its place.

POWER

Power consumption	WHILE IN USE 34.5W on standard configuration. Standard configuration: • LED lights: 23.5W. • Fans in total: 7W. • Other components: 4W. STANDBY MODE 6W. Input 100–240 VAC, 10.0 A, 50–60 Hz.
Outlets	Power socket, USB-C charger. Optional Wireless charger and LAN port.
Output values	Output AC (power socket) 100–240VAC, 6.6A, 50–60 Hz. Output USB C charger: 18W. Output Qi wireless charger: 10W.
Radio networks	LTE-FDD: B1/B2/B3/B4/B5/B7/B8/B12/B13/B18/B19/B20/B25/B26/B28 LTE-TDD: B38/B39/B40/B41 WCDMA: B1/B2/B4/B5/B6/B8/B19 GSM: B2/B3/B5/B8 BLE.
Output powers	BLE 10 dBm, LTE 23 dBm, GSM 850/900 33 dBm, GSM 1800/1900 30 dBm, WCDMA 24 dBm.

DIMENSIONS

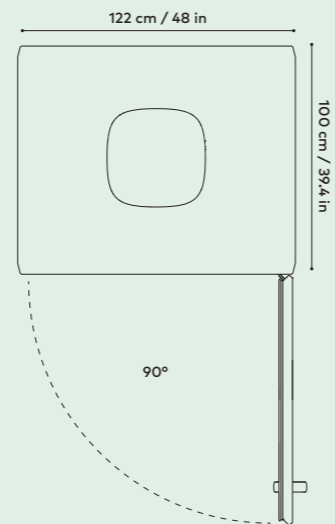
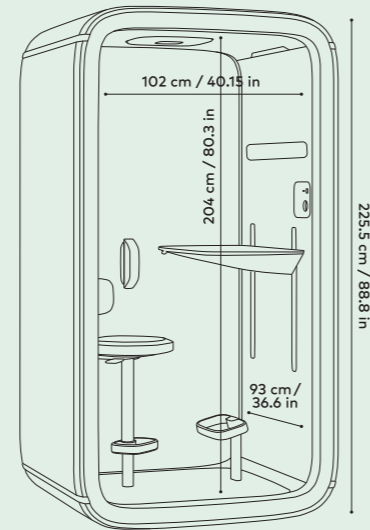

Framery O

TECHNICAL SPECIFICATIONS

Size	EXTERIOR 221 × 100 × 100 cm / 87 × 39.4 × 39.4 in (h, w, d). With castors (comes with movability kit) extra 2 cm / 0.8 in in height. INTERIOR 200 × 80 × 95 cm / 78.7 × 31.5 × 37.4 in (h, w, d). DOORWAY 200 × 80 cm / 78.7 × 31.5 in (h, w).
Weight	320 kg / 705 lb.
Ventilation Space	Min. recommended space for air to circulate: • Sides: 5 cm / 1.9 in. • Above: 15 cm / 5.9 in.
Acoustics	30dB (Speech level reduction according to ISO-23351-1 testing method).
Airflow	Total airflow is 21.5 l/s, 45 CFM (77.4 m³/h). On standby mode the fans are working on 25 % of the maximum power.
Lighting	LED-Light 4000 K and 300 lux.
Exterior materials	EXTERIOR Painted sheet metal. GLASS Sound control laminated glass (4 + 4 mm / 0.16 + 0.16 in). FRAME Formica laminate on birch plywood with varnish trim.
Interior materials	SOLID WALLS AND ROOF A sandwich element of sheet metal, birch plywood, recycled acoustic foam and acoustic felt. FLOOR An anti-static and stain resistant low loop pile carpet. TABLE Formica laminate on birch plywood with varnish trim.
	Power cord can be led out of the bottom corner of the pod. The cord length outside the pods is 4.5 m / 176.4 in.

POWER

Power consumption	WHILE IN USE 13W on standard configuration. Standard configuration: • LED lights: 10W. • Fans in total: 3.1W. STANDBY MODE 0.8W. Input 100–240 VAC, 8.0 A, 50–60 Hz.
Outlets	REGULAR TABLE OUTLETS Power socket. Optional LAN. WIDE TABLE OUTLETS Power socket, USB-A+C. Optional LAN.
Output values	Output AC (power socket) 100–240VAC, 6.6A, 50–60 Hz. Output USB (TUF) charging. Maximum combined output of 5 A at 5 VDC (25 W) dBm.
	All electric components can be changed if there is a malfunction. Power consumption is a constant value that is determined by the power usage of the pods' internal components (electric unit, motion detector, light and fans). Framery's products can be plugged into a wall socket. The pods have their own power supplies that give 24 V DC to the lights and 12 V DC to the fans. The lights and fans are operated by a motion detector. Inside the pods, there are country-specific power outlets for charging mobile devices.

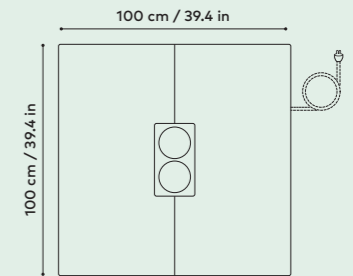
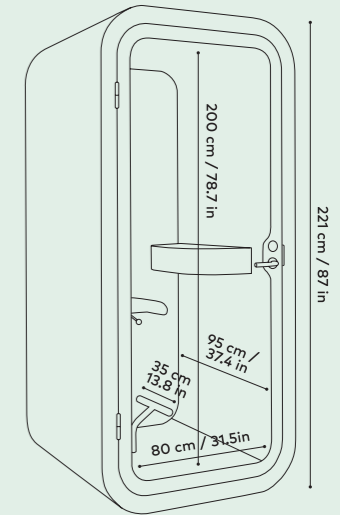

Framery One shipped in North America is UL 962 listed



Framery O is UL GREENGUARD certified



Framery O shipped in North America is UL 962 listed

Framery Q

TECHNICAL SPECIFICATIONS

Size	EXTERIOR 222 x 220 x 120 cm / 87.4 x 86.6 x 47.2 in (h,w,d). With castors (comes with movability kit) extra 2 cm / 0.8 in height.
Weight	630kg / 1389 lb (without furniture)
Ventilation Space	Min. recommended space for air to circulate: <ul style="list-style-type: none"> Sides: 5 cm / 1.9 in Above: 15 cm / 5.9 in
Acoustics	29 dB (Speech level reduction according to ISO 23351-1 testing method)
Airflow	Total airflow is 66 l/s, 140 CFM (237.6 m ³ /h). On standby mode the fans are working on 25 % of the maximum power.
Lighting	LED-Light 4000K and 300lux
Exterior materials	EXTERIOR Painted sheet metal. GLASS Sound control laminated glass 5 + 5 mm / 0.2 + 0.2 in. FRAME Formica laminate on birch plywood with varnish trim.
Interior materials	SOLID WALLS AND ROOF A sandwich element of sheet metal, birch plywood, recycled acoustic foam and acoustic felt. FLOOR An anti-static and stain resistant low loop pile carpet. TABLE White Formica laminate on birch plywood with varnish trim.
	Power cord can be led out of the bottom corner of the pod. The cord length outside the pods is 4.5 m / 176.4 in.

DIMENSIONS

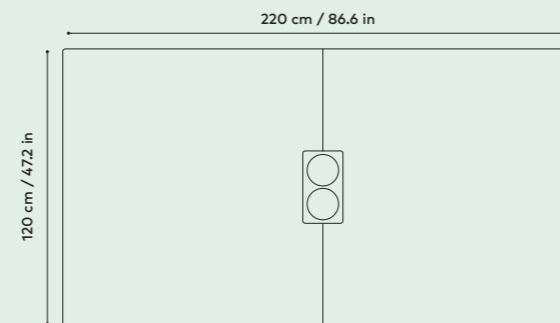
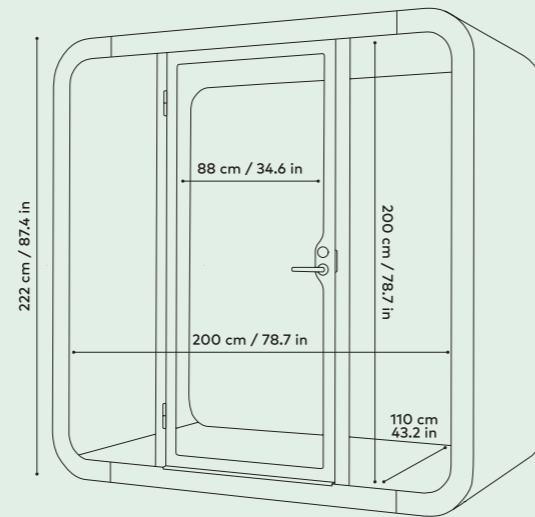

Framery Q Meeting Maggie

TECHNICAL SPECIFICATIONS

Size	EXTERIOR 222 x 220 x 120 cm / 87.4 x 86.6 x 47.2 in (h,w,d). INTERIOR 200 x 200 x 110 cm / 78.7 x 78.7 x 43.2 in (h,w,d). DOORWAY 200 x 88 cm / 78.7 x 34.6 in (h,w).
Lighting	Led light 4000 K and 300 lux.
Ventilation space	Min. recommended space for air to circulate: <ul style="list-style-type: none"> Sides 5 cm / 1.9 in. Above 15 cm / 5.9 in.
Power consumption	WHILE IN USE 20 W on standard configuration. Standard configuration: <ul style="list-style-type: none"> LED lights: 11 W. Fans in total: 8.6 W. STANDBY MODE 2.1 W. Input 100–240 VAC, 8.0 A, 50–60 Hz.
Regular table outlets	2 power sockets USB-A+C. Optional Data Cartridge with two LAN ports.
Turnable Table	70 cm x 71 cm x 53 cm (height, width, depth) 26.4 in x 27.6 in x 20.4 in (height, width, depth).
Sofa Options	Maggie sofas are available with straight backrest (standard) or backrest with armrest. Optional fabrics are available including anti-microbial fabric.
Output values	Output AC (power socket) 100–240VAC, 6.6A, 50–60 Hz. Output USB (TUF) charging: Maximum combined output of 5 A at 5 VDC (25 W).
Screen	Maximum display size 27". Maximum weight 15 kg / 33 lbs with flat VESA 75 x 75 or VESA 100 x 100 mounting surface. Screen not included. Power cord can be led out of the bottom corners of the pod. The cord length outside the pods is 4.5 m / 176.4 in. All electric components can be changed if there is a malfunction. Power consumption is a constant value that is determined by the power usage of the pods' internal components (electric unit, motion detector, light and fans). Framery's products can be plugged into a wall socket. The pods have their own power supplies that give 24 V DC to the lights and 12 V DC to the fans. The lights and fans are operated by a motion detector. Inside the pods, there are country-specific power outlets for charging mobile devices.

DIMENSIONS

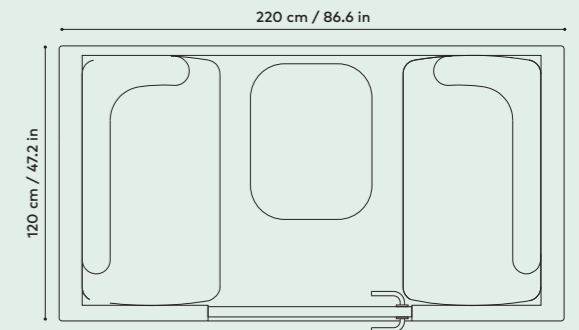
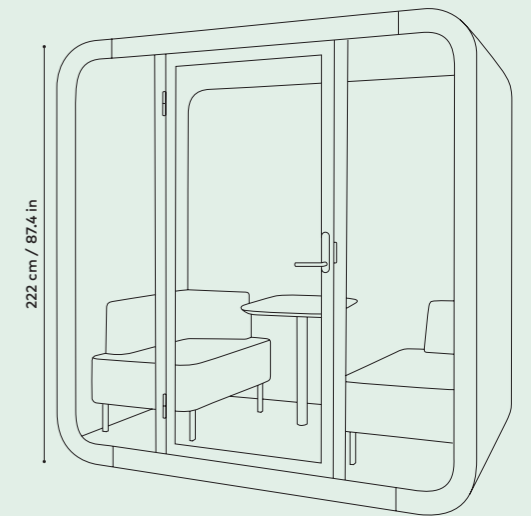

Framery Q is UL GREENGUARD certified



Framery Q shipped in North America is UL 962 listed

Framery Q Flow

TECHNICAL SPECIFICATIONS

Size	EXTERIOR 222 × 220 × 120 cm / 87.4 × 86.6 × 47.2 in (h,w,d). INTERIOR 200 × 200 × 110 cm / 78.7 × 78.7 × 43.2 in (h, w, d). DOORWAY 200 × 88 cm / 78.7 × 34.6 in (h, w).
Lighting	Led light 4000K and 300 lux.
Ventilation space	Min. recommended space for air to circulate: <ul style="list-style-type: none"> • Sides: 5 cm / 1.9 in. • Above: 15 cm / 5.9 in.
Power consumption	WHILE IN USE 20W on standard configuration. <p>Standard configuration:</p> <ul style="list-style-type: none"> • LED lights: 11 W. • Fans in total: 8.6 W. <p>STANDBY MODE 2.1 W. Input 100–240 VAC, 8.0 A, 50–60 Hz.</p>
Regular table outlets	2 power sockets, USB-A+C Optional Data cartridge with two LAN ports
Output values	Output AC (power socket) 100–240VAC, 6.6A, 50–60 Hz. Output USB (TUF) charging Maximum combined output of 5 A at 5 VDC (25W).
Table	100 × 56 cm / 39.4 × 22 in (w, d) 65–125 cm / 25.6–49.2 in (h) Weight limit: 60 kg / 2.2 lb

Power cord can be led out of the bottom corners of the pod. The cord length outside the pods is 4.5 m / 176.4 in.

All electric components can be changed if there is a malfunction. Power consumption is a constant value that is determined by the power usage of the pods' internal components (electric unit, motion detector, light and fans). Framery's products can be plugged into a wall socket. The pods have their own power supplies that give 24 V DC to the lights and 12 V DC to the fans. The lights and fans are operated by a motion detector. Inside the pods, there are country-specific power outlets for charging mobile devices.

DIMENSIONS

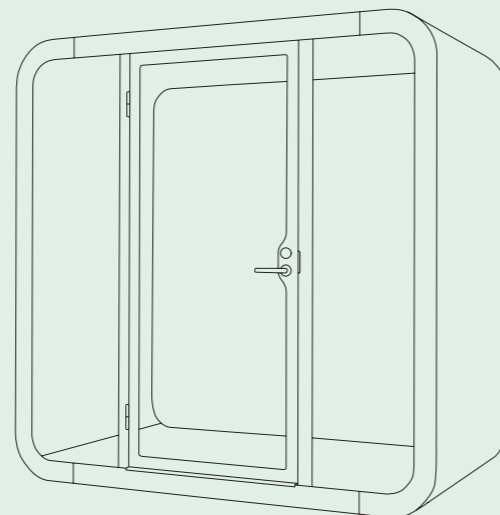
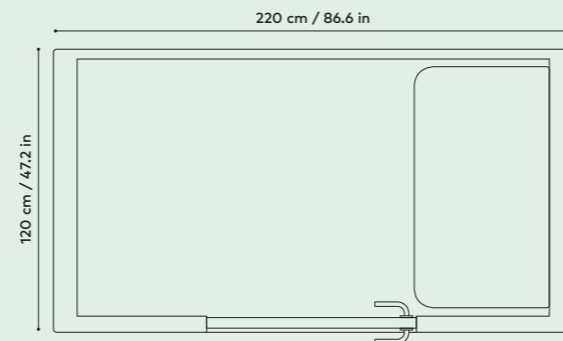
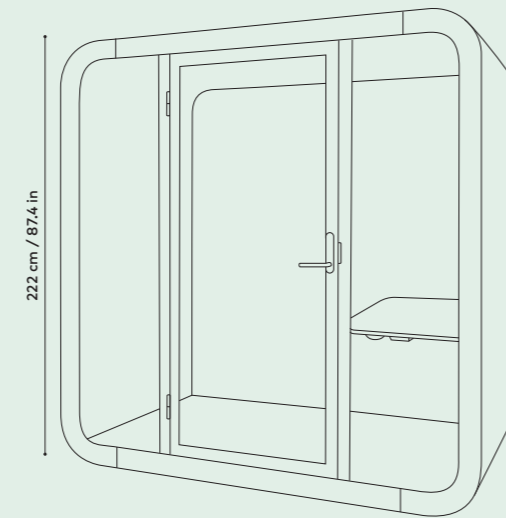

Framery Q Flip n' Fold

TECHNICAL SPECIFICATIONS

Size	EXTERIOR 222 × 220 × 120 cm / 87.4 × 86.6 × 47.2 in (h, w,d). INTERIOR 210 × 200 × 110 / 81.6 × 78.7 × 43.2 in (h, w,d). DOORWAY Clear opening width 91.5 cm / 36 in.
Weight	700 kg / 1543 lb.
Lighting	Led light 4000K and 300 lux.
Ventilation space	Min. recommended space for air to circulate: <ul style="list-style-type: none"> • Sides: 5 cm / 1.9 in. • Above: 15 cm / 5.9 in.
Power consumption	WHILE IN USE 23 W on standard configuration. <p>Standard configuration:</p> <ul style="list-style-type: none"> • LED lights: 13.5W. • Fans in total: 8.6W. <p>STANDBY MODE 2.1W. Input 100–240 VAC, 8.0 A, 50–60 Hz.</p>
Regular outlets	2 power sockets USB-A+C.
Seat	Black Plywood, black fabric. Wall mounted foldable seats.
Foldable table	73 × 70 cm / 28.7 × 27.5 in (w, d). Table height 72cm / 28.3 in.

Wheelchair platform 99 × 60 cm / 39 in × 22.8 in (w, d). Framery Q Flip n' Fold features ADA 2010 compliant T-shaped turning space and threshold.

Output values Output AC (power socket) 100–240VAC, 6.6A, 50–60 Hz. Output USB (TUF) charging: Maximum combined output of 5 A at 5 VDC (25 W).

Door Left handed, minimum clear opening width 91.5 cm / 36 in. Automatic door opener button (height 105 cm / 41.3 in).

Power cord can be led out of the bottom corners of the pod. The cord length outside the pods is 4.5 m / 176.4 in.

All electric components can be changed if there is a malfunction. Power consumption is a constant value that is determined by the power usage of the pods' internal components (electric unit, motion detector, light and fans). Framery's products can be plugged into a wall socket. The pods have their own power supplies that give 24 V DC to the lights and 12 V DC to the fans. The lights and fans are operated by a motion detector. Inside the pods, there are country-specific power outlets for charging mobile devices.

DIMENSIONS

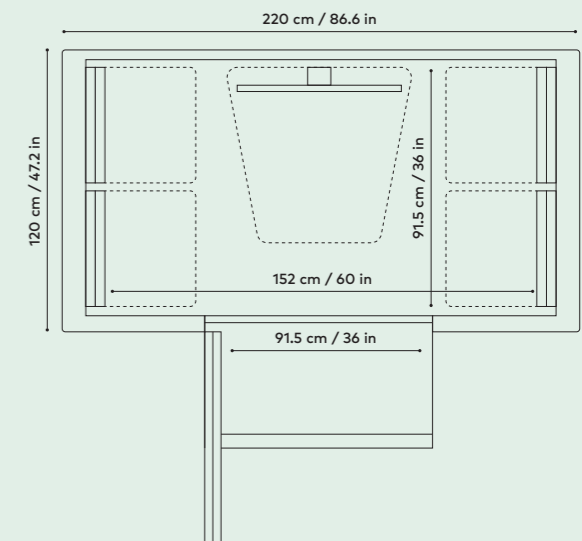
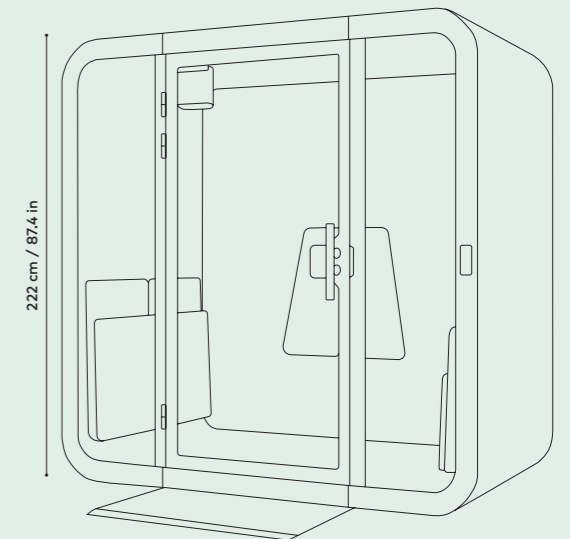

Framery 2Q

TECHNICAL SPECIFICATIONS

Size	EXTERIOR 222 x 235 x 280 cm / 87.4 x 92.5 x 110.2 in (h, w, d).
Weight	950 kg / 2094 lb (without furniture).
Ventilation Space	Min. recommended space for air to circulate: <ul style="list-style-type: none"> • Above: 15 cm / 5.9 in.
Acoustics	29dB (Speech level reduction according to ISO-23351-1 testing method).
Airflow	Total airflow is 121 l/s, 256 CFM (436 m³/h). On standby mode the fans are working on 25 % of the maximum power.
Lighting	LED-Light 4000 K and 400 lux
Exterior materials	EXTERIOR Painted sheet metal. GLASS Sound control laminated glass (5+5 mm / 0.16+0.16in). FRAME Formica laminate on birch plywood with varnish trim.
Interior materials	SOLID WALLS AND ROOF A sandwich element of sheet metal, birch plywood, recycled acoustic foam and acoustic felt. FLOOR An anti-static and stain resistant low loop pile carpet. TABLE Formica laminate on birch plywood with varnish trim.

DIMENSIONS

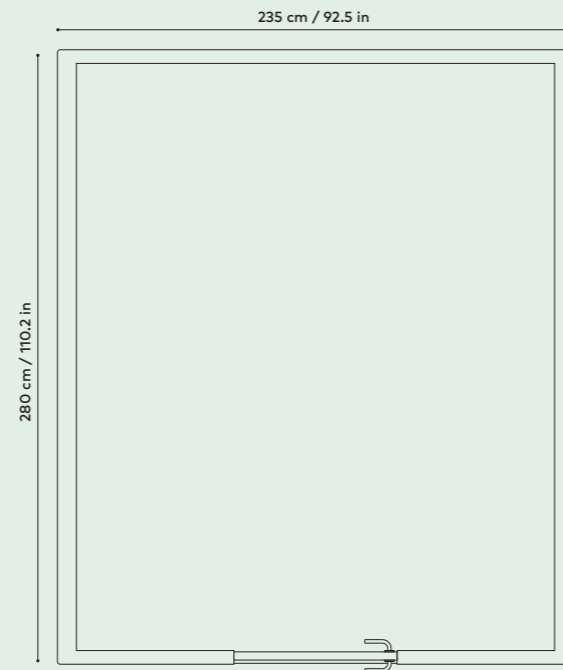
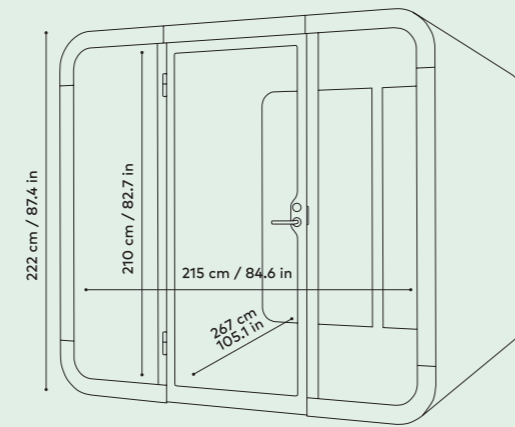

Framery 2Q Huddle

TECHNICAL SPECIFICATIONS

Size	EXTERIOR 222 x 235 x 280 cm / 87.4 x 92.4 x 110.2 in (h,w,d). INTERIOR 210 x 215 x 267 cm / 81.6 in x 84.6 x 105.1 in (h,w,d). DOORWAY 86 cm / 33.6 in wide.
Lighting	Led light: 4000 K and 400 lux.
Ventilation space	Min. recommended space for air to circulate: <ul style="list-style-type: none"> • Sides: 15 cm / 5.9 in.
Power consumption	WHILE IN USE 42 W on standard configuration. Standard configuration: <ul style="list-style-type: none"> • LED lights: 24 W. • Fans in total: 18 W. STANDBY MODE 5 W. Input 100-240 VAC, 8.0 A, 50-60 Hz.
Huddle Table	140 x 86 cm / 54 x 33.6 in (l, w). Working height options 72 cm / 28.3 in and 110 cm / 43.3 in.
Outlets	On table 4 power sockets, USB-A+C, HDMI. Optional LAN (replaces 1 power socket). Under table 2 power sockets.
Output values	Output AC (power socket) 100-240VAC, 6.6A, 50-60 Hz. Output USB (TUF) charging Maximum combined output of 5 A at 5 VDC (25 W).
Screen specifications	Display bracket on the table wall. Possibility to mount a display on the opposite wall. Screen not included. Maximum display size 50". Maximum weight 30 kg / 66 lbs. VESA support 100x100, 100x150, 150 x 100, 200 x 100, 100 x 200, 200 x 200, 300 x 200, 400 x 200. Power cord can be led out of the bottom from backside of the pod, the length is 3.5m / 136.8 in. All electric components can be changed if there is a malfunction. Power consumption is a constant value that is determined by the power usage of the pods' internal components (electric unit, motion detector, light and fans). Framery's products can be plugged into a wall socket. The pods have their own power supplies that give 24 V DC to the lights and 12 V DC to the fans. The lights and fans are operated by a motion detector. Inside the pods, there are country-specific power outlets for charging mobile devices.

DIMENSIONS

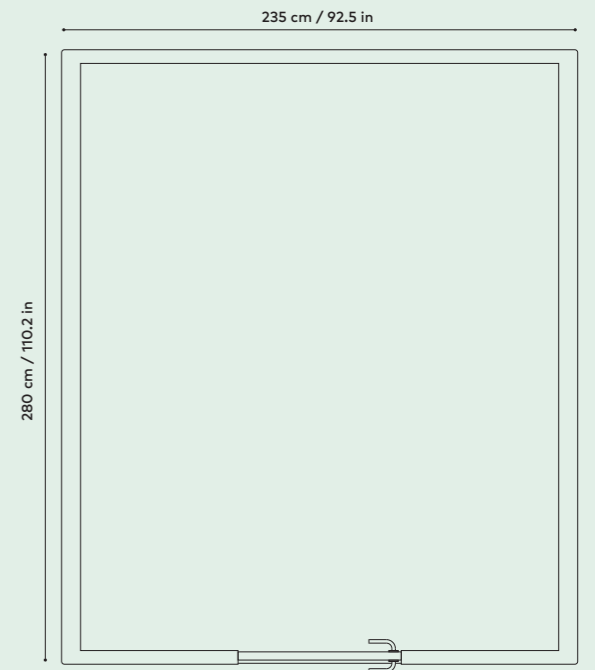
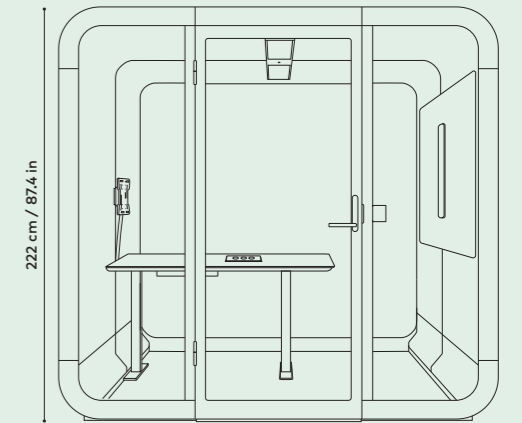

Framery 2Q is UL GREENGUARD certified



Framery 2Q shipped in North America is UL 962 listed

Framery 2Q Lounge

TECHNICAL SPECIFICATIONS

Size	EXTERIOR 222 × 235 × 280 cm / 87.4 × 92.4 × 110.2 in (h,w,d). INTERIOR 210 × 215 × 267 cm / 81.6 × 84.6 × 105.1 in (h, w, d). DOORWAY 86 cm / 33.6 in wide.
Lighting	Led light: 4000 K and 400 lux.
Ventilation space	Min. recommended space for air to circulate: <ul style="list-style-type: none"> • Above: 15 cm / 5.9 in.
Power consumption	WHILE IN USE 42 W on standard configuration. <p>Standard configuration:</p> <ul style="list-style-type: none"> • LED lights: 24 W. • Fans in total: 18 W. <p>STANDBY MODE 5 W. Input 100–240 VAC, 8.0 A, 50–60 Hz.</p>
Lounge wall shelf	175 cm / 68.4 in (length).
Lounge Piaggio table	62 × 42 × 36 cm / 24.4 × 16.5 × 14.1 in (h, w, d).
Outlets	6 power sockets, 2 USB-A+C, Optional Data Cartridge with 2 LAN ports.
Whiteboard	240 × 100 cm / 93.6 × 39.4 in (w, h).
Output values	Output AC (power socket) 100–240VAC, 6.6A, 50–60 Hz. Output USB (TUF) charging: Maximum combined output of 5 A at 5VDC (25 W).
Screen specifications	Located on the centre of the lounge whiteboard. Screen not included. <p>Maximum display size 50". Maximum weight 30 kg / 66 lbs. Tilting angle +5/-8°. VESA support 100 × 100, 100 × 150, 150 × 100, 200 × 100, 100 × 200, 200 × 200, 300 × 200, 400 × 200.</p> <p>Power cord can be led out of the bottom from backside of the pod, the length is 3.5m / 136.8 in.</p> <p>All electric components can be changed if there is a malfunction. Power consumption is a constant value that is determined by the power usage of the pods' internal components (electric unit, motion detector, light and fans). Framery's products can be plugged into a wall socket. The pods have their own power supplies that give 24 V DC to the lights and 12 V DC to the fans. The lights and fans are operated by a motion detector. Inside the pods, there are country-specific power outlets for charging mobile devices.</p>

DIMENSIONS

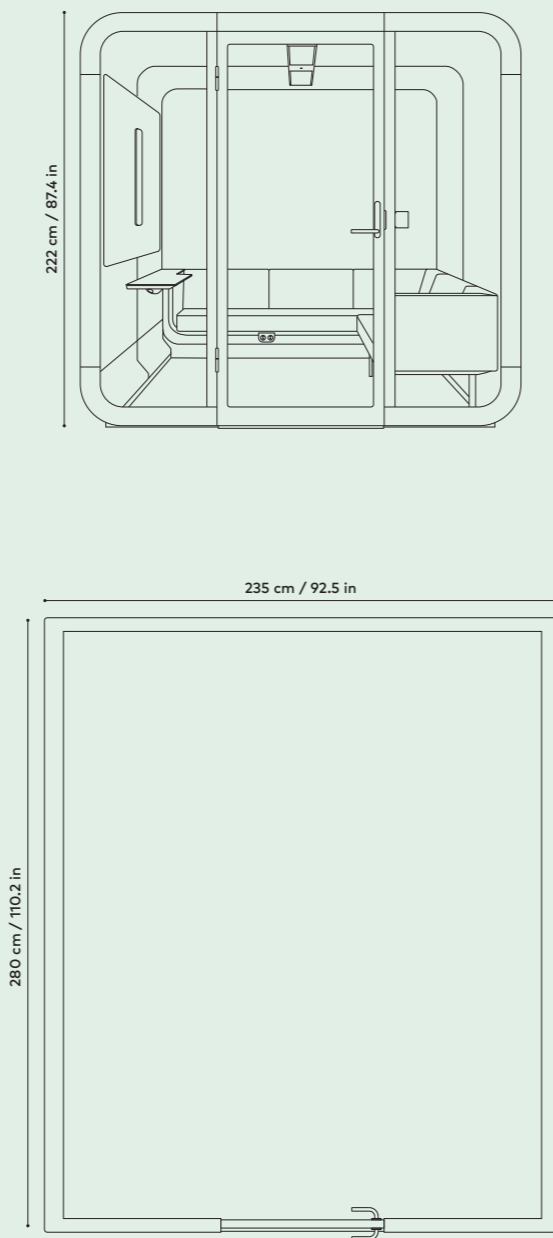

Framery 2Q Without furniture

TECHNICAL SPECIFICATIONS

Size	EXTERIOR 222 × 235 × 280 cm / 87.4 × 92.4 × 110.2 in (h,w,d). INTERIOR 210 × 215 × 267 cm / 81.6 × 84.6 × 105.1 in (h,w,d). DOORWAY 86 cm / 33.6 in wide.
Lighting	Led light: 4000 K and 400 lux.
Ventilation space	Min. recommended space for air to circulate: <ul style="list-style-type: none"> • Sides: 5 cm / 1.9 in.
Power consumption	WHILE IN USE 42 W on standard configuration. <p>Standard configuration:</p> <ul style="list-style-type: none"> • LED lights: 24 W. • Fans in total: 18 W. <p>STANDBY MODE 5 W. Input 100–240 VAC, 8.0 A, 50–60 Hz.</p>
Outlets	3 power sockets, USB-A+C, Optional: LAN (replaces 1 power socket).
Output values	Output AC (power socket) 100–240VAC, 6.6A, 50–60 Hz. Output USB (TUF) charging: Maximum combined output of 5 A at 5 VDC (25 W).
	Power cord can be led out of the bottom from backside of the pod, the length is 3.5m / 136.8 in.
	All electric components can be changed if there is a malfunction. Power consumption is a constant value that is determined by the power usage of the pods' internal components (electric unit, motion detector, light and fans). Framery's products can be plugged into a wall socket. The pods have their own power supplies that give 24 V DC to the lights and 12 V DC to the fans. The lights and fans are operated by a motion detector. Inside the pods, there are country-specific power outlets for charging mobile devices.

DIMENSIONS

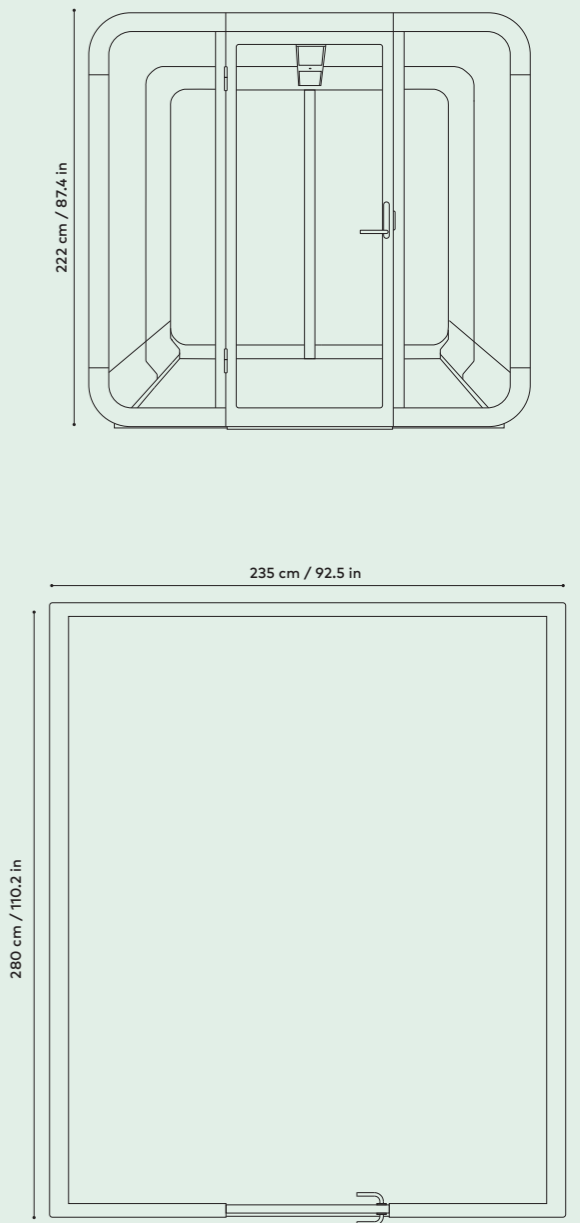

Framery's management system has been certified according to the ISO 9001 Quality Management System standard, ISO 14001 Environmental Management System standard, and ISO 45001 Occupational Health and Safety Management System standard. CE marking is a manufacturer's declaration that a product meets the requirements of relevant EC directives. The EC directives for Framery O, Q, and 2Q pods are: Low Voltage Directive (LVD) 2006/95/EC, Electromagnetic Compatibility Directive (EMC) 2004/108/EC, Restriction of Hazardous Substances (RoHS) Directive 2011/65/EU and Ecodesign Directive 2009/125/EC.

Acoustics

Phone booths and meeting pods can be used to eliminate distractions and increase productivity in the workplace, but this is only achieved if they are actively used. To reach their full potential, pods must be placed close enough to their users. This creates certain requirements especially in terms of sound insulation. The required level of sound insulation for pods, expressed in practical terms, is that they can be placed right next to workstations in an office and people working outside them will not be able to overhear discussions inside. This is especially important in the case of on-demand use of single-person pods.

ISO 23351-1 is a new standard that can be used to measure the level of pods' sound insulation as a whole and to produce a single figure, called

speech level reduction, which describes the degree of provided speech privacy. A speech level reduction of 30 dB corresponds with the practical requirement of sound insulation mentioned above. With a lower level of sound insulation, pods should be placed further away from people working outside them.

In addition to sound insulation, interior acoustics of pods are another factor to take into consideration. Poor interior acoustics make it difficult to hear what's being said during phone calls and meetings. This also causes users to raise their voices, which creates another problem in terms of privacy.

Reverberation time is typically used to describe the interior acoustics of a space. Unfortunately, it's not possible to reliably test reverberation time in pods because of their small

size. However, the surface area and thickness of absorptive materials inside a pod are good indicators of its acoustics. Also, as with sound insulation, it's important to test pods in practice and make sure that speech sounds natural inside them.

Framery O, Q, 2q

FIRE SAFETY No flammable materials are used in Framery products. The fire safety of all surface materials, upholstery and acoustics materials of the products are tested and classified by either national or international standards. EN 13501-1 classification for the used materials is the following: acoustic wool is classified B-s1, d0, acoustic felt B-s2, d0, and carpet Bfl-s1. Wall, ceiling, and floor panels have also been tested against ASTM E84 / UL 723 and are classified

as Class A. Moulded foam and fabrics used in seating meets CAL TB 117:2013 requirements. Fabric meets the performance requirements of BS EN 1021-1 and 1021-2. According to KIWA Inspecta, an EU accredited inspection body, there is no need for installing sprinklers in Framery O, Q, or 2Q in Europe. Framery has conducted extensive fire testing in the US for the products and results suggest that there is no need for installing sprinklers in Framery O, Q, and 2Q in North America either. It is still recommended to check the requirements with the local AHJ / fire inspector in North America as interpretations may differ.

MATERIAL SAFETY We conduct emissions testing for the products every time a major update is planned for Framery products in order to be sure that there aren't any harmful compounds volatilizing from the products such as formaldehydes or VOCs. All Framery products are certified against UL GreenGuard and tested against M1 emissions standard of Finnish Building Information Foundation RTS levels. We want to embrace transparency of the materials we use for our products and thus we have compiled Health Product Declarations® (HPD) for our products. Our HPDs can be found and downloaded for free online from the Health Product Declaration Collaborative public repository.

SUSTAINABILITY Framery O, Q & 2Q consist mostly of plywood, steel, glass, and acoustic materials. Plywood used in Framery products has a sustainable forestry FSC or PEFC certification. Sound dampening panels are made up to 60% and the felt panels are made up to 80% of recycled PET plastic (e.g. plastic bottles). A significant part of all steel, aluminum, and glass is recycled during their manufacturing processes. 3rd Party Certifier has con-

ducted a Life Cycle Assessment (LCA) and compiled Environmental Product Declarations (EPD) for both Framery O, Framery Q, and Framery 2Q.

Framery One

FIRE SAFETY No flammable materials are used in Framery products. The fire safety of all surface materials, upholstery and acoustics materials of the products are tested and classified by either national or international standards. EN 13501-1 classification for the used materials is the following: acoustic wool is classified B-s1, d0, acoustic felt B-s2, d0, and carpet Bfl-s1. Wall, ceiling, and floor panels have also been tested against ASTM E84 / UL 723 and are classified as Class A. Moulded foam and fabrics used in seating meets CAL TB 117:2013 requirements. Fabric meets the performance requirements of BS EN 1021-1 and 1021-2. According to KIWA Inspecta, an EU accredited inspection body, there is no need for installing sprinklers in Framery O, Q, or 2Q in Europe. Framery has conducted extensive fire testing in the US for the products and results suggest that there is no need for installing sprinklers in Framery O, Q, and 2Q in North America either. It is still recommended to check the requirements with the local AHJ / fire inspector in North America as interpretations may differ.

MATERIAL SAFETY We conduct emissions testing for the products every time a major update is planned for Framery products in order to be sure that there aren't any harmful compounds volatilizing from the products such as formaldehydes or VOCs. All Framery products are certified against UL GreenGuard and tested against M1 emissions standard of Finnish Building Information Foundation RTS levels. Framery One has achieved the highest possible

GreenGuard Gold certification level. We want to embrace transparency of the materials we use for our products and thus we have compiled Health Product Declarations® (HPD) for our products. Our HPDs can be found and downloaded for free online from the Health Product Declaration Collaborative public repository.

SUSTAINABILITY Framery One consists mostly of steel, glass, and acoustic dampening materials – All of which are highly recyclable materials. The sound dampening panels are made up to 60% recycled PET plastic (e.g. Plastic bottles). Significant part of all steel, aluminum, and glass is recycled during their manufacturing processes.

Framery is the industry
pioneer and global
leader in engineering and
manufacturing soundproof
pods, services and solutions
that enable people at work
to connect, and focus on
what really matters.

framery