

# Framery Four™



The smart and soundproof office meeting pod  
shaping the workspace of tomorrow

**framery**



Framery Four is a smart office meeting pod for up to 4 people. This multifunctional soundproof meeting space is engineered for face-to-face meetings and hybrid work from the office. Fine-tuned acoustics and soundproofing provides privacy for discussions and virtual calls. Framery Four's adaptive ventilation and automated lighting let you focus on what really matters and have a successful workday.

## Framery Four / Product highlights



### Workdays that flow with ease

Framery Four has been purposefully designed to make your workdays flow better. Find and book the pod in advance or on-the-fly from the Framery app. Or step inside and the pod automatically creates a reservation for you. Extend your reservation directly from the pod's touchscreen, or adjust your booking through the app.



### Privacy you can trust

The fine-tuned acoustic structure provides A-Class soundproofing that allows the pod to be placed next to workstations without causing noise distractions to the user or to those outside of the pod. And echo-free interior acoustics make the pod a private, comfortable place for work and video calls.



### Airflow that keeps you fresh

The pod recognizes when it's occupied, senses the temperature and humidity of the surroundings, and triggers adjustments to the airflow accordingly. Enhanced ventilation fully refreshes the air every minute, and ventilation can be easily adjusted through the pod's touchscreen.



### Lighting that makes you feel good

Multiple automated light sources adapt to your needs, with preset lighting options to choose between work or video modes. Video-optimized lighting helps you shine on video calls. Adjustments can be made quickly and easily through the touchscreen display.

## Framery Four / Tech features



### 1. A-CLASS SOUNDPROOFING

Guaranteed privacy with fine-tuned Class A speech level reduction of 30dB – and the industry's top ISO 23351-1 rating for office phone booths.

### 2. FRAMERY OFFICE SOUND MASKING SYSTEM™

The embedded system is based on patent-pending technology that reduces noise distractions and protects speech privacy in office environments by adding a subtle, unobtrusive background sound outside of the pod. This ambient background noise, similar to air flow, is specifically designed to blend in with the office's noise atmosphere – making sounds less intelligible and therefore less distracting.

### 3. ADAPTIVE VENTILATION

Proprietary design enables unparalleled ventilation with maximum airflow of 100 l/s – surpassing industry standards around the world

### 4. TEMPERATURE & HUMIDITY SENSORS

Sensors inside the pod recognize the temperature and humidity of the office environment, and automatically optimize the airflow accordingly.

### 5. AUTOMATIC LIGHTING MODES

Multiple adjustable 4000K LED light sources allow you to seamlessly switch between video or work modes – or make manual adjustments for personalized illumination.

### 6. 8-INCH TOUCHSCREEN

An intuitive, 8-inch high-resolution touchscreen makes it easy to control pod settings, adjust lighting and airflow, and extend calendar reservations effortlessly.

### 7. AUTOMATIC UPGRADES

A built-in 4G connection enables automatic over-the-air software updates – initiated instantly and silently in the background.

### 8. MMWAVE RADAR PRESENCE DETECTION

Millimeter-wave radar sensors immediately detect when someone enters or leaves the pod, allowing lighting and ventilation to adjust accordingly.

Occupancy data is gathered and displayed through Framery Connect to provide information about when the pod is being used the most.

### 9. FRAMERY CONNECT™

Gain insights from occupancy data, initiate advanced bookability functionalities, and connect your Framery Four to the entire office to get valuable usage data needed to improve the layout and efficiency of your workplace.

### 10. BOOKABLE PODS

Make your smart pod bookable like any meeting room. The pod's touchscreen will show reservations and you can manage them on the spot.

---

## Framery Four / Design details

Framery Four easily fits any office thanks to its efficient size and sleek design. The interior is luxurious in space, easily fitting two comfortable sofas and lots of table space. The low threshold enables easy access. Choose from a variety of colors and interior options to make the pod fit your environment seamlessly. Framery Four is designed sustainable and built to last.



Framery Four's powder-coated exterior panels are made from deepdrawn and bended steel. Matt black structures made from aluminum create the framing, and sound-control laminated glass finish the structural support.

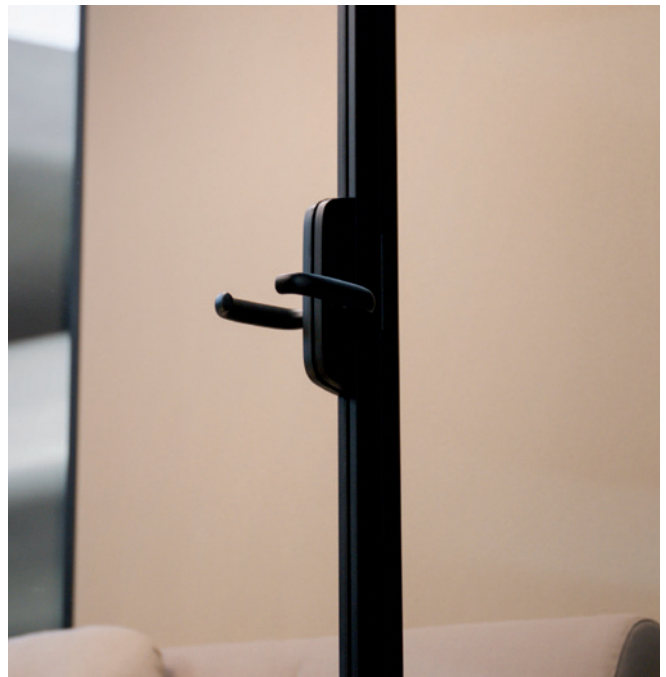

The pod chassis is made of a light steel structure. Replaceable interior paneling are made from PET sound-absorbing material. Anti-static, stain resistant low-loop pile carpeting covers the flooring.



The exterior occupancy lights show at a glance whether the pod is available or already taken.



The custom-designed table comfortably accommodates laptops, and built-in power outlets and optional coat hooks support all your office accessories. An optional adjustable monitor arm can be inserted directly into the table leg to support a 27" screen.

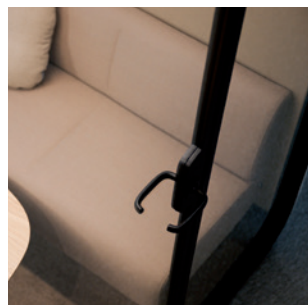

The sofas of Framery Four are specially designed to fit four people comfortably. Custom cushions are available for additional comfort and support.

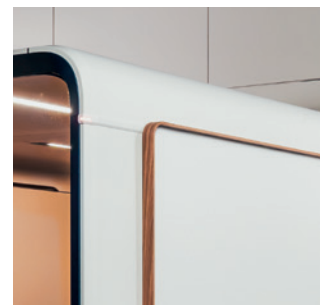





An optional gather zone outside of Framery Four creates an additional meeting area, featuring a convenient add-on rail where a whiteboard or additional display can be attached.

# Framery Four / Colors and finishes

## EXTERIORS

	White (Standard) RAL 9016 Ultramatt
	Black (Standard) RAL 9005 Ultramatt
	Gray (Standard) S 7500 - N Ultramatt
	Navy S 7020 - R90B Ultramatt
	Sand S 2010 - Y20R Ultramatt
	Powder Blue 3421-R86B Ultramatt
	Winter Moss S 7010-G10Y Ultramatt
	Blush 2728-R01B Ultramatt



## INTERIORS

	Pure Gray (Standard) Tonal #60123 Gabriel
	Arctic Blue Tonal #66185 Gabriel
	Sand Tonal #61180 Gabriel
	Rouge Tonal #64210 Gabriel

## CARPETS

	Light Gray (Standard) Fletco carpets
	Dark Blue Fletco carpets
	Champagne Fletco carpets
	Grape Fletco carpets

## TABLE TOPS

	White (Standard) White laminate
	Black Black Laminate with anti-fingerprint surface
	Oak Veneer

## SEATING FABRICS

	Graphite (Standard) Select #60051 Gabriel
	Dark Blue Select #66144 Gabriel
	Grape Select #61190 Gabriel
	Rose Select #65117 Gabriel
	Powder Blue Select #67098 Gabriel
	Beige Select #61184 Gabriel
	Green Select #68209 Gabriel
	Mustard Select #62098 Gabriel

## CUSHIONS FOR FRAMERY FOUR

	Charcoal Capture #5501 Gabriel
	Latte Capture #3301 Gabriel

Design your own  
on our website



## MATERIALS AND FINISHES



**EXTERIOR PANELS** made from steel feature a powder-coated matt finish. The lightweight panels are joined together seamlessly, with elegant curves that create a timeless design.



**INTERIOR PANELS** made from high-quality and recycled polyester have a vibrant and dynamic look thanks to the mix of the two-colored fabric.

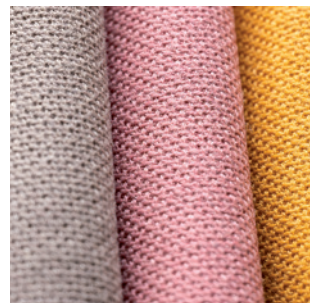

**SEATING MATERIALS** are a blend of superior New Zealand wool and polyamid that form a soft and rich texture. The extremely durable fabrics are both dirt and water repellent.



**CARPET FLOORING** is anti-static, stain resistant, and durable, giving the pod an overall soft look and finish.

---

## Framery smart office solutions / Set your office up for success

Framery's smart office solutions help create a productive and flexible office with simple yet powerful workplace management technology while enhancing the employee experience with seamless, intuitive room booking solutions. Gather insights from the entire workplace and make data-driven office development decisions. Streamline the workday flow with smart booking solutions, allowing users to book any spaces—on the spot or on the go.

### WORKPLACE MANAGEMENT

Lead with data from your whole office

### ROOM BOOKING SOLUTIONS

Enhance employee experience

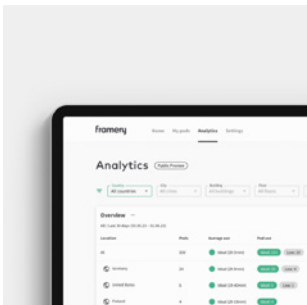

#### Framery Connect™

A smart platform for workplace management.



#### Framery Connect Sensor™

Usage data from any space.

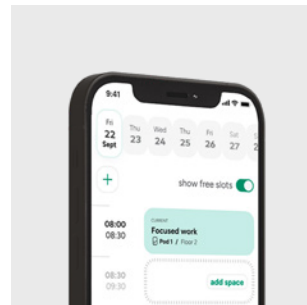

#### Framery App™

Find and book spaces in seconds.

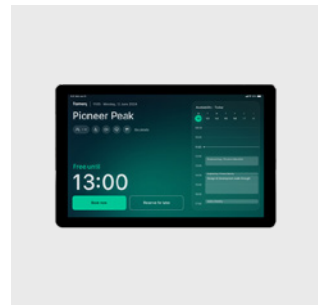

#### Framery Room Display™

Book any room with ease.

#### Unparalleled support

Get instant support from a Framery specialist for any issues that may arise with your smart pods or other products.

#### Automatic updates

Instantly receive software updates through your smart pod's 4G connection to enable developments and services into the future.

#### Privacy assured

No identifiable user data is collected – only workspace occupancy information is tracked.

---

### FRAMERY PLUS – EVERYTHING YOU NEED FOR A SUCCESSFUL WORKPLACE

Unlock all the tools and features your workplace needs to thrive with our subscription based Framery Plus™ – new smart pod customers receive a complimentary 1-year subscription.



Read more

# Framery smart pods / Environmental data sheet

Framery's new smart pods set the standard in sustainability – with durability that is measured in decades, light-weight product structures, use of truly recyclable materials, and modularity that allows the life cycle of the products to be extended indefinitely. Framery participates in the Science Based Targets initiative, and has set emission reduction targets aligned with the goal of limiting global warming to 1.5°C compared to pre-industrial levels.



## Optimal material use

Framery has achieved a 23% material reduction with its new line of products – which equals over 1 million kg of raw material annually – while increasing their level of performance compared to previous models. The carbon footprint in the manufacturing stage of the new products is 16% smaller on average. A change from plywood to steel as the main construction material also allows Framery to continue reducing its environmental impact and strive towards a 50% reduction in product CO2 emissions by 2028.



## Production and waste management

All our pods are manufactured in Tampere, Finland using zero-emission electricity. Our factory logistics are operated on biogas and renewable diesel. The material efficiency rate of our production was 94.9% in 2022. Virtually no waste goes to landfill.



## Environmental impact

We have conducted life cycle assessment studies for our products to measure their environmental

impacts. Alongside their carbon footprint, we also study other impacts such as resource depletion and water scarcity. The results are verified by an independent third party, and then published and registered as an EPD to provide stakeholders with reliable information on our products' environmental performance in a transparent way.



## Product performance

The modular design of our pods facilitates a long product lifetime, and our customers typically use them for many years. The same pod can be used by one customer after another, enabling multiple life cycles and saving valuable resources. Thanks to their modular design, our pods are easy to disassemble, refurbish if needed, and reassemble at a new location. Our products are GREENGUARD Gold certified, and highly maintainable with easily available spare parts.



## Transportation

Logistical hubs in Singapore and the USA reduces air freight, and allows us

to load our shipping containers more tightly. The products are made-to-order, and their modularity helps us achieve this with minimal impact.



## Materials

To increase circularity, the pods contain mono-materials rather than composites for 100% recyclability. They also contain more recycled materials, including 20% recycled steel and aluminum, 29% recycled glass, and fabric featuring 80% recycled plastic. Framery will also be among the select few companies in the world pioneering the use of SSAB fossil-free steel in our products, starting as soon as the material becomes available in 2026.



## Certificates and studies available

- Life Cycle Assessment (LCA)
- Environmental Product Declarations (EPD)
- Health Product Declarations (HPD) & Declare labels
- UL GREENGUARD Gold
- Contribution to Green Building Certifications such as LEED, BREEAM, SKA and WELL

100% END OF LIFE  
RECYCLABILITY  
\*Framery One 95%



80 %  
RECYCLED PET



20 %  
RECYCLED STEEL



29%  
RECYCLED GLASS



CERTIFIED  
TEXTILES



CERTIFIED  
WOOD



# Framery Four™

## Technical specifications

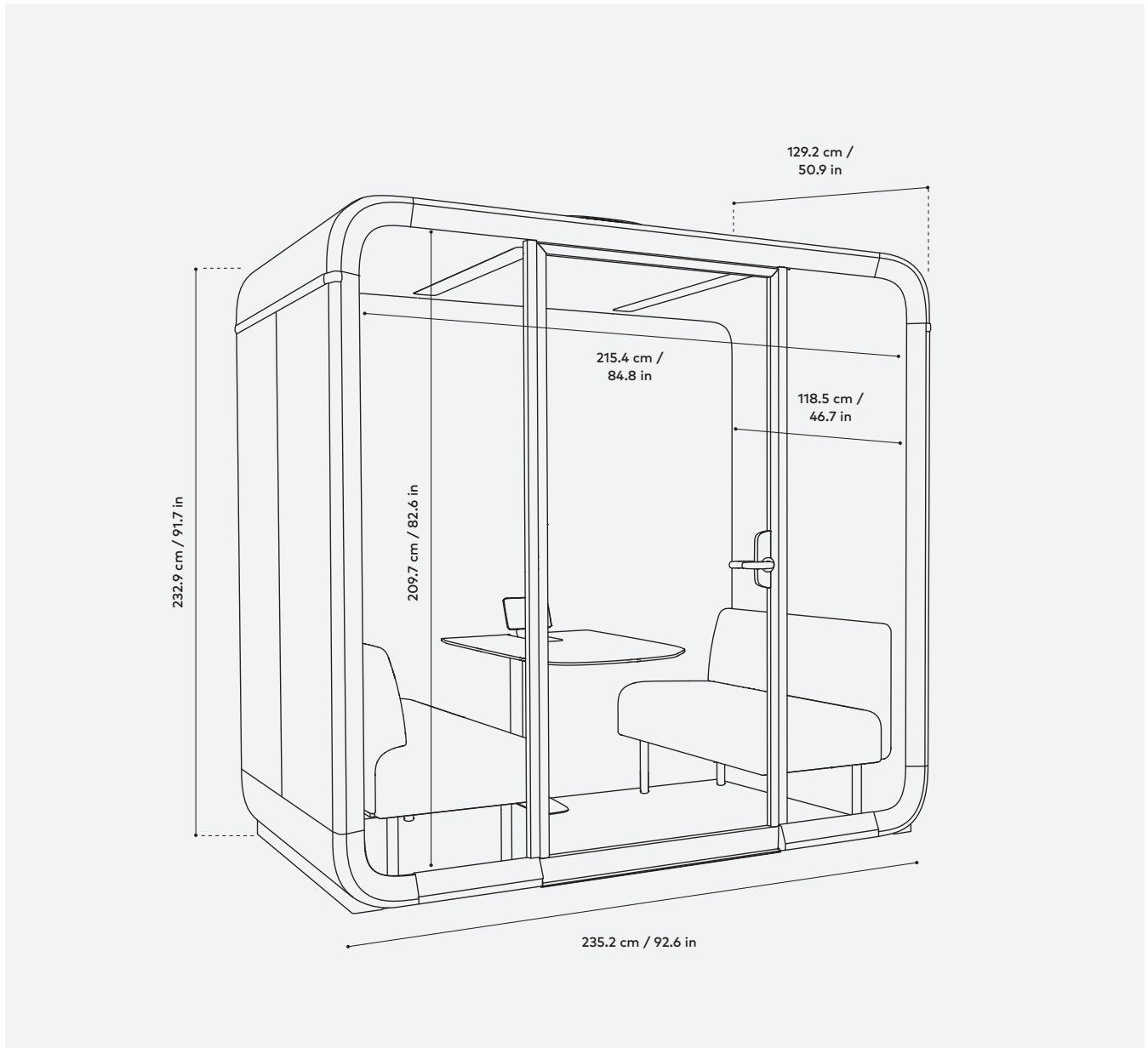

### Performance

Speech level reduction: 30dB  
Max airflow: 100 l/s  
Low energy consumption: 52W

### Sustainable design

Built to last for decades  
Light-weight product structures  
Refurbishable & movable

### Connectivity

Built-in 4G connection  
Automatic software updates  
Framery Connect digital services

# Framery Four / Technical specifications

## OVERVIEW

Soundproofing	<b>CLASS A 30 DS,A (dB) reduction</b> Speech level reduction DS,A (dB) is measured using ISO 23351-1. Pod can be placed next to workspaces without compromising privacy
Sound masking	<b>FRAMERY OFFICE SOUND MASKING SYSTEM™</b> A pre-fitted sound masking system improves the soundscape of the office outside the pods with an effective radius of 5 m / 16 ft
Ventilation	<b>MAXIMUM AIRFLOW</b> 100 l/s, 212 CFM (360.2 m <sup>3</sup> /h) <b>DEFAULT AIRFLOW</b> 78 l/s, 165 CFM (280 m <sup>3</sup> /h) when in use. After use, the pod refreshes itself with a higher ventilation speed. <b>STANDBY MODE</b> 40 l/s, 85 CFM, (144 m <sup>3</sup> /h) <b>ADJUSTABLE DIRECTIONAL AIRFLOW</b> Choose between direct and indirect airflow
Lighting	<b>CEILING LIGHT</b> Color temperature 4000K, illuminance up to 500lux on the table top. <b>VIDEO LIGHT</b> Color temperature 4000K, illuminance up to 350lux on the user's face. <b>PRE-SET LIGHTING MODES</b> Standard mode & Video call mode. Lighting can also be adjusted also manually
Presence detection	<b>SENSOR TECHNOLOGY</b> mmWave radar
Dimensions	<b>EXTERIOR</b> with air filter housing 232.9 × 235.2 × 129.2 cm / 91.7 × 92.6 × 50.9 in (h, w, d) <b>DOORWAY</b> 209.7 × 96.6 cm / 82.6 × 38 in (h, w) <b>WEIGHT</b> 520 kg / 1146.4 lb (Framery Four Base 460 kg / 208.7 lb) <b>THRESHOLD</b> 1.25 cm / 0.5 in
Touchscreen location	On the table (Framery Four Base: on the wall, right side)
Connectivity	Framery smart pods gather anonymous occupancy data, measuring when and how often spaces are used. Users in the space cannot be identified and no personally identifiable data is collected. The anonymous data is transferred via built-in 4G connectivity, or through a Wi-Fi connection and compiled and shown in the Framery Connect platform. <b>WLAN</b> Wi-Fi 802.11 a/b/g/n/ac 2.4&5 GHz

## DIMENSIONS / MAIN VIEW

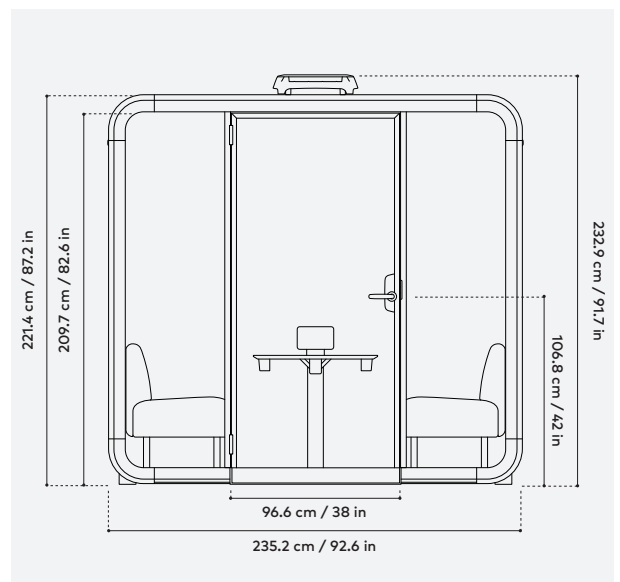
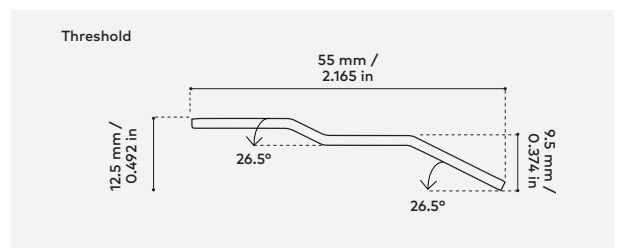
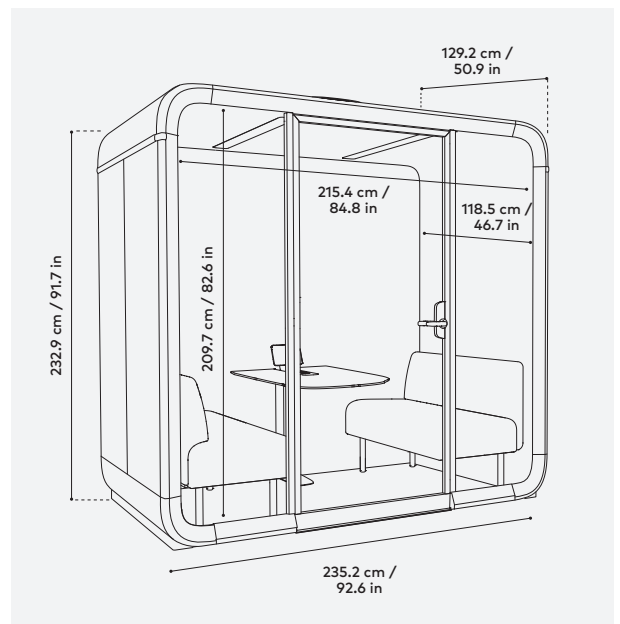

Framery Four is UL GREENGUARD GOLD certified



Framery Four shipped in North America is UL 962 listed

# Framery Four / Technical specifications

## MATERIALS

Exterior & structure	<b>EXTERIOR PANELS</b> Powder coated matt steel panels. <b>FRAMES</b> Structure matt black aluminum <b>DOOR FRAME</b> Structure matt black aluminum <b>GLASS</b> Sound control laminated glass (4 + 4 mm / 0.16 + 0.16 in) <b>CHASSIS</b> Light steel and PET sound-absorbing structure <b>HANDLE</b> Custom-designed black metal
Interior materials	<b>INTERIOR PANELS</b> PET sheets laminated with recycled polyester fabric <b>UPHOLSTERY FABRIC</b> Gabriel Tonal <b>CARPET</b> Antistatic and stain resistant low loop pile carpet <b>CUSHIONS</b> Gabriel Capture <b>TABLE</b> Table top is birch plywood laminated with white, black anti-fingerprint, or oak veneer <b>TABLE LEG</b> Structure black metal
Seating materials	<b>UPHOLSTERY FABRIC</b> Gabriel Select <b>FABRIC COMPOSITION</b> 85 % New Zealand wool / 15 % Polyamide
Furniture dimensions	<b>TABLE</b> 70.6 cm x 90 cm / 27.8 x 35.4 in (w, d) Fixed height from floor 71.9 cm / 28.3 in <b>MAX LOAD FOR THE TABLE</b> 60 kg / 131 lb <b>SOFA</b> 110 x 60.5 cm (w, d) / 43.3 in x 23.8 in. Fixed seating height from floor 47 cm / 18.5 in (backrest height cm 78,5 / 30.9 in) <b>MAX LOAD FOR SOFA</b> 408 kg / 900 lb
Optional accessories	<b>MONITOR ARM</b> Rotating monitor arm with VESA mounting bracket. Monitor not included. Compatible with 24" - 27" monitors (max 15 kg / 33 lb) with a flat 75 x 75 mm or 100 x 100 mm center-positioned VESA mounting surface. <b>COAT HOOKS</b> Structure black metal <b>CUSHIONS</b> Gabriel Capture – 85 % New Zealand wool / 15 % Polyamide <b>EXTERIOR TABLET MOUNT</b> With easy set-up

## DIMENSIONS / TOP VIEW

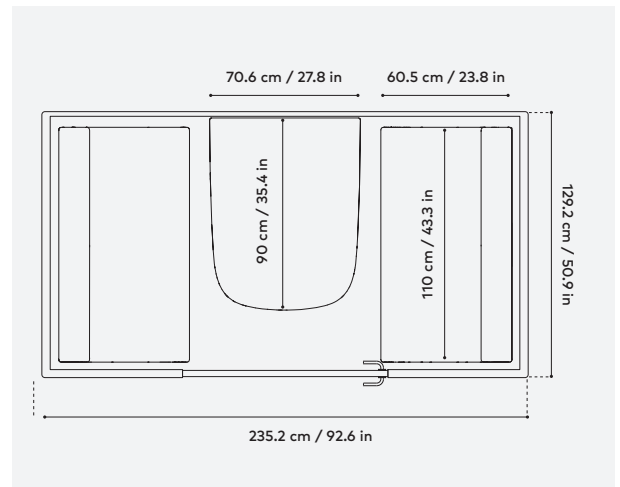

## SAFETY

Fire safety	No fire hazardous materials are used in Framery pods. The fire safety of all surface materials, upholstery and acoustics materials of our products are tested and classified by either national or international standards. Framery provides additional safety measurements to adhere to local regulatory requirements
Seismic safety	A seismic anchoring kit for a pod is available for the seismic regions. The kit consists of brackets that further reinforce the pod structure to withstand heavy seismic forces

# Framery Four / Technical specifications

## POWER AND SPACE REQUIREMENTS

### Power

#### FRAMERY FOUR ESSENTIALS OUTLETS

4 x under-table power outlets, 2 x USB-C PD charge ports (65 W). Optional: 2 x under-table power outlets (included with the monitor arm). Optional in-table outlets (max. 2): 0-1 x HDMI port, 0-2 x LAN ports (with cables)

**FRAMERY FOUR LITE OUTLETS** 4 x under-table power outlets. Optional: 2 x under-table power outlets (included with the monitor arm). Optional in-table outlets (max 4): 0-2 x USB-C PD charge ports (65 W), 0-1 x HDMI port, 0-4 x LAN ports (with cables)

**FRAMERY FOUR BASE OUTLETS** 4 x power outlets (2 x power outlets on each side of the pod). Optional outlets (max 4): 0-2 x USB-C PD charge ports (65 W), 0-4 x LAN ports (with cables)

The location of power outlets may vary based on country regulations.

**POWER CONSUMPTION** Default settings 52W. Highest settings 115W. Standby mode 20W. **INPUT** 100-240 VAC, 10 A\*, 50-60 Hz. **OUTPUT AC (POWER OUTLET)** 100-240 VAC (8 A max) 50-60 Hz. **OUTPUT USB-C PD CHARGE PORT** 65W

\*In India power outlet type 16A is used

### Space requirements

**DOOR SWING ANGLE 180°**

### Door handedness

Left-handed by default (can also be installed right-handed)

### Operating space

From back to front (pod depth + doorway) 225.8 cm / 88.9 in. Room height requirement 238 cm / 93.7 in

### Installation space

Installation requires 50 cm / 19.7 in of free space around the pod. Room height requirement 238 cm / 93.7 in.

### Movability

Relocate the pod without the need for disassembly by adding casters with a movability kit. Compatible with Framery Four and Six. The kit is reusable. Multiple pods can be moved with one kit

## SHIPPING CRATE DIMENSIONS

### Crate 1

**SIZE** 226 x 75 x 138 cm / 90 x 29.5 x 54.3 in (l, w, h). **WEIGHT** 278 kg / 612.9 lb

### Crate 2

**SIZE** 224 x 74 x 114 cm / 88.2 x 29.1 x 44.9 in (l, w, h). **WEIGHT** 395 kg / 870.8 lb

Crate 1 is stacked on top of Crate 2

## DIMENSIONS / POWER CORD SPECIFICATIONS

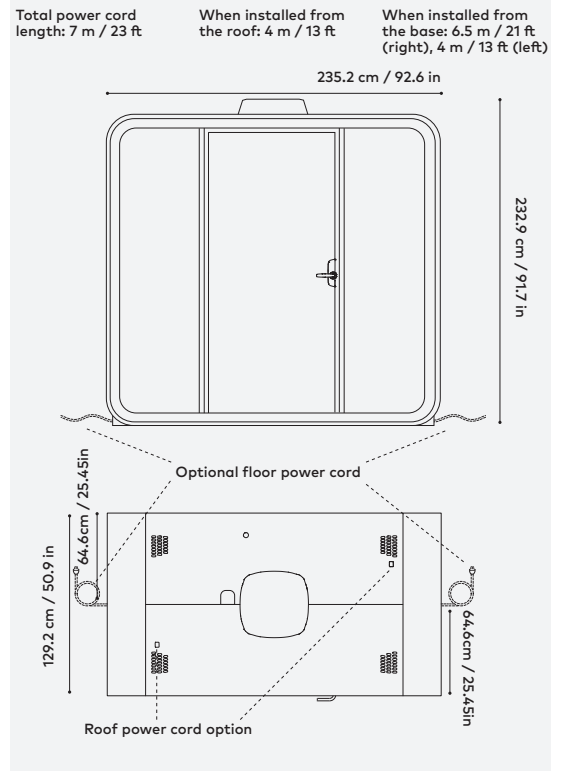

## DIMENSIONS / OPERATING SPACE

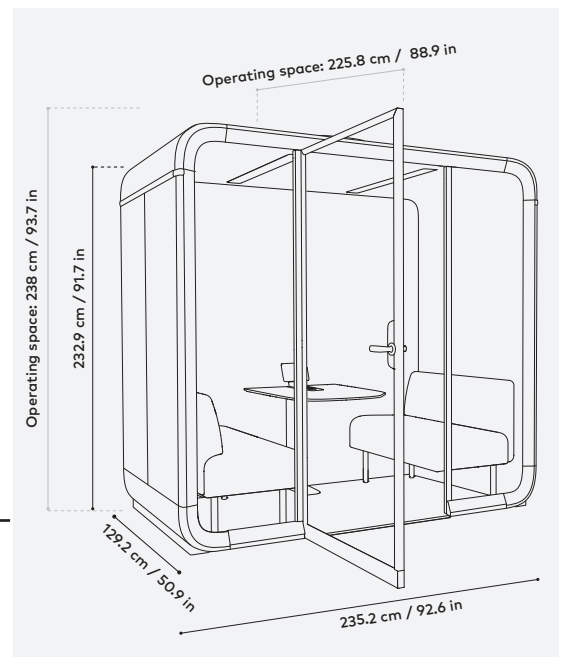

For the doers,  
leaders, thinkers,  
dreamers, creators,  
teams, pioneers  
and innovators.  
**For people who  
get it done.**