

Framery Four™



The smart and soundproof office meeting pod
shaping the workspace of tomorrow

framery



Framery Four is a smart office meeting pod for up to 4 people. This multifunctional soundproof meeting space is engineered for face-to-face meetings and hybrid work from the office. Fine-tuned acoustics and soundproofing provides privacy for discussions and virtual calls. Framery Four's adaptive ventilation and automated lighting let you focus on what really matters and have a successful workday.

Framery Four / Product highlights



Workdays that flow with ease

Framery Four has been purposefully designed to make your workdays flow better. Find and book the pod in advance or on-the-fly from the Framery app. Or step inside and the pod automatically creates a reservation for you. Extend your reservation directly from the pod's touchscreen, or adjust your booking through the app.



Privacy you can trust

The fine-tuned acoustic structure provides A-Class soundproofing that allows the pod to be placed next to workstations without causing noise distractions to the user or to those outside of the pod. And echo-free interior acoustics make the pod a private, comfortable place for work and video calls.



Airflow that keeps you fresh

The pod recognizes when it's occupied, senses the number of people, the temperature and humidity of the surroundings, and triggers adjustments to the airflow accordingly. Enhanced ventilation fully refreshes the air every minute, and ventilation can be easily adjusted through the pod's touchscreen.



Lighting that makes you feel good

Multiple automated light sources adapt to your needs, with preset lighting options to choose between work or video modes. Video-optimized lighting helps you shine on video calls. Adjustments can be made quickly and easily through the touchscreen display.

Framery Four / Tech features



1. A-CLASS SOUNDPROOFING

Guaranteed privacy with fine-tuned Class A speech level reduction of 30dB – and the industry's top ISO 23351-1 rating for office phone booths.

2. FRAMERY OFFICE SOUND MASKING SYSTEM™

The embedded system is based on patent-pending technology that reduces noise distractions and protects speech privacy in office environments by adding a subtle, unobtrusive background sound outside of the pod. This ambient background noise, similar to air flow, is specifically designed to blend in with the office's noise atmosphere – making sounds less intelligible and therefore less distracting.

3. ADAPTIVE VENTILATION

Proprietary design enables unparalleled ventilation with maximum airflow of 100 l/s – surpassing industry standards around the world

4. TEMPERATURE & HUMIDITY SENSORS

Sensors inside the pod recognize the temperature and humidity of the office environment, and automatically optimize the airflow accordingly.

5. AUTOMATIC LIGHTING MODES

Multiple adjustable 4000K LED light sources allow you to seamlessly switch between video or work modes – or make manual adjustments for personalized illumination.

6. 8-INCH TOUCHSCREEN

An intuitive, 8-inch high-resolution touchscreen makes it easy to control pod settings, adjust lighting and airflow, and extend calendar reservations effortlessly.

7. AUTOMATIC UPGRADES

A built-in 4G connection enables automatic over-the-air software updates – initiated instantly and silently in the background.

8. MMWAVE RADAR PRESENCE DETECTION

Millimeter-wave radar sensors immediately detect when someone enters or leaves the pod, allowing lighting and ventilation to adjust accordingly.

Occupancy data is gathered and displayed through Framery Connect to provide information about when the pod is being used the most.

9. FRAMERY CONNECT™

Gain insights from occupancy data, initiate advanced bookability functionalities, and connect your Framery Four to the entire office to get valuable usage data needed to improve the layout and efficiency of your workplace.

10. BOOKABLE PODS

Make your smart pod bookable like any meeting room. The pod's touchscreen will show reservations and you can manage them on the spot.

Framery Four / Design details

Framery Four easily fits any office thanks to its efficient size and sleek design. The interior is luxurious in space, easily fitting two comfortable sofas and lots of table space. The low threshold enables easy access. Choose from a variety of colors and interior options to make the pod fit your environment seamlessly. Framery Four is designed sustainable and built to last.



Framery Four's powder-coated exterior panels are made from deepdrawn and bended steel. Matt black structures made from aluminum create the framing, and sound-control laminated glass finish the structural support.

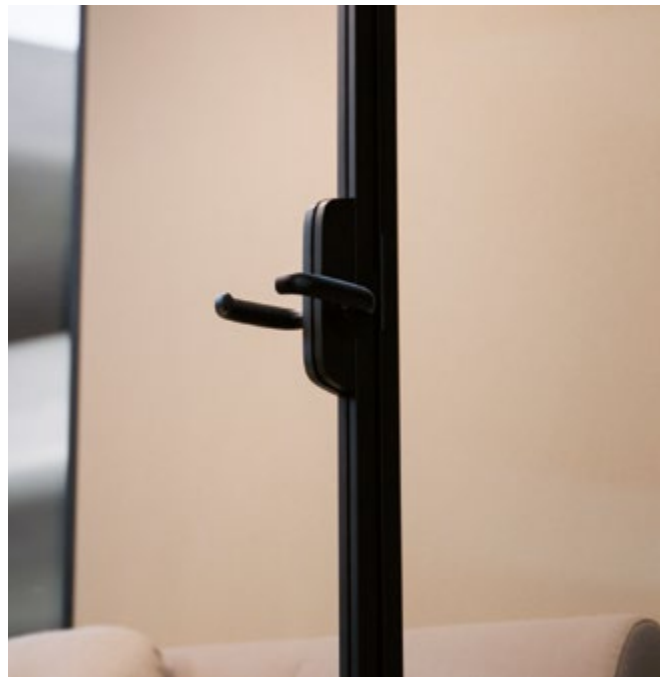

The pod chassis is made of a light steel structure. Replaceable interior paneling are made from PET sound-absorbing material. Anti-static, stain resistant low-loop pile carpeting covers the flooring.



The exterior occupancy lights show at a glance whether the pod is available or already taken.



The custom-designed table comfortably accommodates laptops, and built-in power outlets and optional coat hooks support all your office accessories. An optional adjustable monitor arm can be inserted directly into the table leg to support a 27" screen.

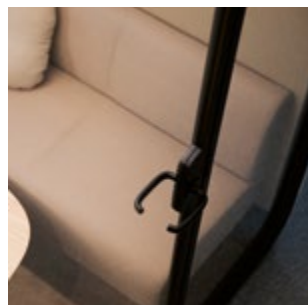

The sofas of Framery Four are specially designed to fit four people comfortably. Custom cushions are available for additional comfort and support.

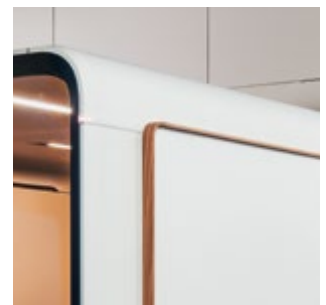





An optional gather zone outside of Framery Four creates an additional meeting area, featuring a whiteboard or additional display can be attached.

Framery Four / Colors and finishes

EXTERIORS

	White (Standard) RAL 9016 Ultramatt
	Black (Standard) RAL 9005 Ultramatt
	Gray (Standard) S 7500 - N Ultramatt
	Navy S 7020 - R90B Ultramatt
	Sand S 2010 - Y20R Ultramatt
	Powder Blue 3421-R86B Ultramatt
	Winter Moss S 7010-G10Y Ultramatt
	Blush 2728-R01B Ultramatt



INTERIORS

	Pure Gray (Standard) Tonal #60123 Gabriel
	Arctic Blue Tonal #66185 Gabriel
	Sand Tonal #61180 Gabriel
	Rouge Tonal #64210 Gabriel

CARPETS

	Light Gray (Standard) Fletco carpets
	Dark Blue Fletco carpets
	Champagne Fletco carpets
	Grape Fletco carpets

TABLE TOPS

	White (Standard) White laminate
	Black Black Laminate with anti-fingerprint surface
	Oak Veneer

SEATING FABRICS

	Graphite (Standard) Select #60051 Gabriel
	Dark Blue Select #66144 Gabriel
	Grape Select #61190 Gabriel
	Rose Select #65117 Gabriel
	Powder Blue Select #67098 Gabriel
	Beige Select #61184 Gabriel
	Green Select #68209 Gabriel
	Mustard Select #62098 Gabriel

CUSHIONS FOR FRAMERY FOUR

	Charcoal Capture #5501 Gabriel
	Latte Capture #3301 Gabriel

Design your own
on our website



MATERIALS AND FINISHES



EXTERIOR PANELS made from steel feature a powder-coated matt finish. The lightweight panels are joined together seamlessly, with elegant curves that create a timeless design.



INTERIOR PANELS made from high-quality and recycled polyester have a vibrant and dynamic look thanks to the mix of the two-colored fabric.

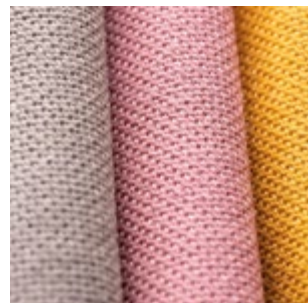

SEATING MATERIALS are a blend of superior New Zealand wool and polyamid that form a soft and rich texture. The extremely durable fabrics are both dirt and water repellent.



CARPET FLOORING is anti-static, stain resistant, and durable, giving the pod an overall soft look and finish.

Framery smart office solutions / Make any space smart with Framery

Framery smart office solutions are workplace tools that help workplace managers make data-driven office design decisions and access workplace insights through intuitive dashboards. The seamless room booking solutions deliver a premium employee experience.

Pair the solutions with Framery smart pods, or turn any office space into a smart workspace.



NEW

Framery Room Sensor™

WORKPLACE MANAGEMENT Utilize private and advanced occupancy and people-counting data to create the ideal work environment for both focused solo work and collaboration. Identify underutilized and improperly used spaces to make precise layout adjustments, effectively cutting costs and maximizing real estate ROI.

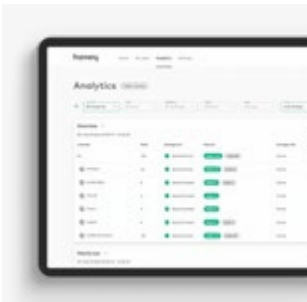

Framery Connect™

WORKPLACE MANAGEMENT
A smart platform for workplace management.

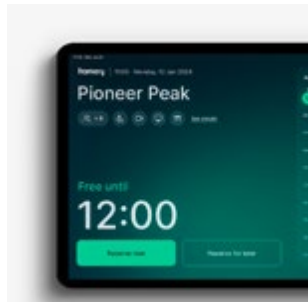

Framery Room Display™

ROOM BOOKING SOLUTIONS
See availability and book any room with ease.



Framery Space Overview™

ROOM BOOKING SOLUTIONS
Shows real-time availability of nearby spaces.

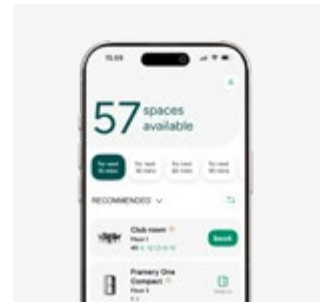

Framery App™

ROOM BOOKING SOLUTIONS
Find and book spaces in seconds.

Accessory kits

Add a complete hardware kit for your Framery Room Display and Space Overview, or use your own equipment.

Automatic updates

Instantly receive software updates through your smart pod's 4G connection to enable the future developments.

Privacy assured

No identifiable user data is collected —only workspace occupancy information is tracked.

FREE SUBSCRIPTION FOR NEW SMART POD OWNERS

Receive a complimentary 3-month Plus subscription, giving access to all our smart office solutions.

Read more



Framery smart pods / Environmental data sheet

Made with waste – not to waste.

The “fast furniture” trend means 80% of office furniture ends up in landfills. We wanted to create a pod that's part of the solution, not the problem. That's why we build our pods optimizing the use of recycled materials, and more importantly, design them to last decades. Plus, our smart office solutions help maximize space usage.

Framery measures its impact holistically and there are three primary focus areas: Climate and Environment, People and Society, and Fair Business. We annually publish the sustainability report and update our Environmental Product Declarations (EPDs), which are based on third-party party reports and validation. Additionally, Framery has a positive net impact ratio meaning that the company creates more value compared to the resources it uses.

UN Global Compact & Science Based Targets initiative

We participate in the UN Global Compact as well as the Science Based Targets initiative and have set emission-reduction targets aligned with the goal of limiting global warming to 1.5°C compared to pre-industrial levels. We have also set a target to reduce our emissions per pod by more than 50% by 2028 compared to 2023.

Material and environmental efficiency

We aim to reduce our reliance on virgin materials by optimizing recycled whenever possible, while balancing that goal with

material availability and ensuring our pods remain durable and high-quality.

Our smart pods feature:

- interior carpet with 20% recycled content
- interior panels with 60-70% recycled material
- sound-absorbing panels with 50-60% recycled content
- glass typically with 20-33% recycled content
- steel and aluminum with 0-30% recycled content (due to global demand)

The material efficiency rate describes the volume of waste in relation to the input materials. In 2024, our material efficiency reached 95.7% at our factory. More than half of the waste generated is bio-based waste that is directed to incineration with energy recovery. We don't use any water in our manufacturing processes.

Sustainability throughout the pod's lifecycle

Leveraging their smart features and connectivity, even after manufacturing, our smart pods can receive over-the-air (OTA) updates that further improve their sustainability. We have already released an OTA update that automatically reduced the lifetime electricity usage by approximately 30% which contributed to a lower carbon footprint for all manufactured and connected smart pods globally—no input was required from the smart pod owners.

The most efficient pod is the one used to its fullest extent and our smart office solutions help customers to maximize pod utilization. From ensuring pods are easy to book and comfortable to use, to optimizing their occupancy, our range of digital products helps ensure a long, productive life for our smart pods.

The majority of the pods' components are modular, refurbishable and easily replaceable to ensure decades of use. Because the smart pods are so durable and easy to relocate, there is also a second-hand market for our pods.

Certificates and studies available:

- Life Cycle Assessment (LCA)
- Environmental Product Declarations (EPDs)
- Health Product Declarations (HPD)
- Declare labels
- Möbelfakta
- UL GREENGUARD Gold
- Contribution to green building certifications such as LEED certifications, BREEAM, SKA and WELL



Framery has been awarded with a Silver Medal sustainability rating from Ecovadis sustainability – placing us among the top 8% percent of companies assessed in the past year.



Framery holds the Certified Autism Resource (CAR) designation, earned after an IBCCES expert board certified its product aligns with competency areas to meet the needs of individuals with autism.



Find the sustainability report and the smart pods' EPDs by scanning the QR code or go to framery.com.

Framery Four™

Technical specifications

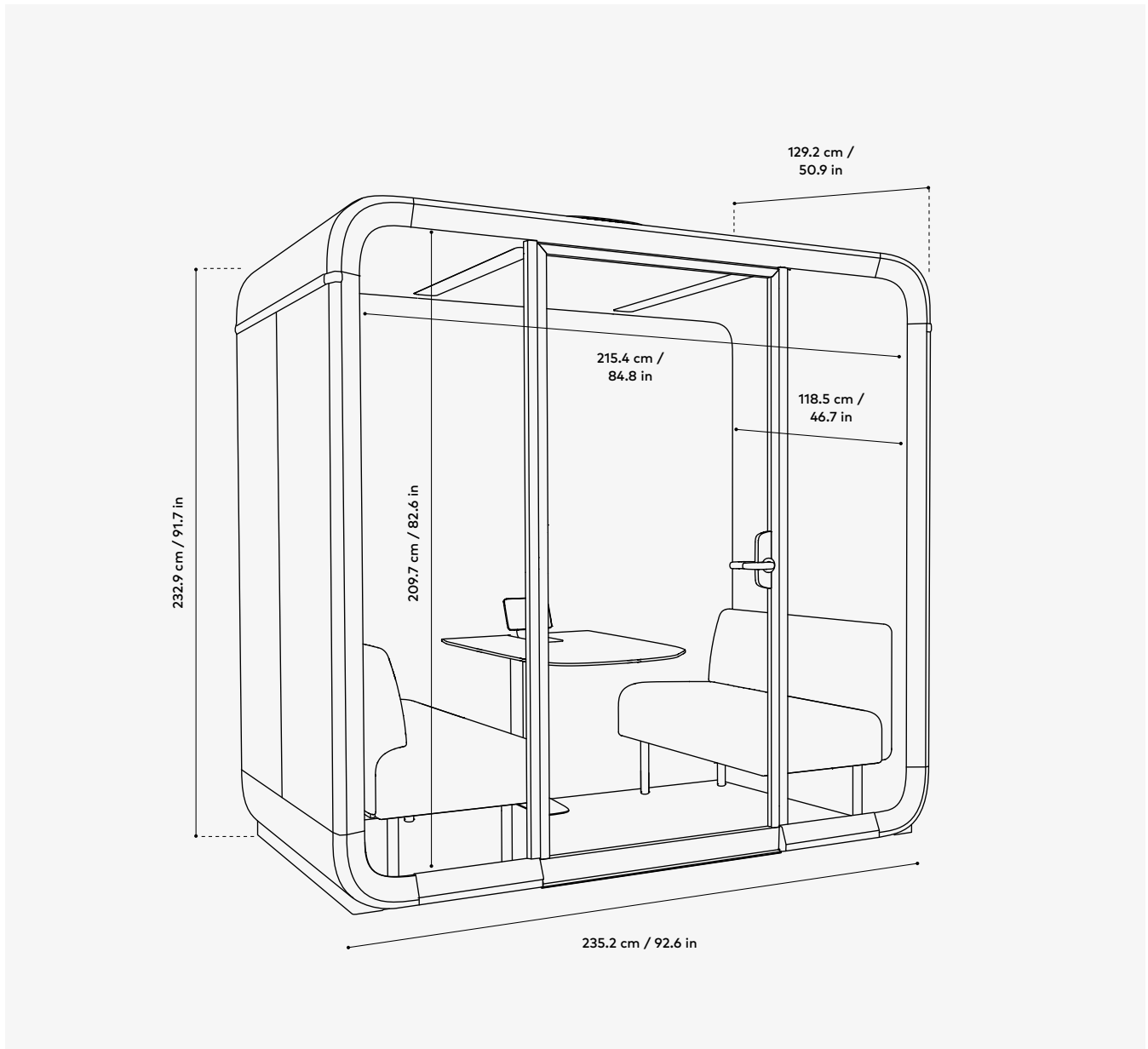

Performance

Speech level reduction: 30dB
Max airflow: 100 l/s
Low energy consumption: 52W

Sustainable design

Built to last for decades
Light-weight product structures
Refurbishable & movable

Connectivity

Built-in 4G connection
Automatic software updates
Framery Connect digital services

Framery Four / Technical specifications

OVERVIEW

Soundproofing	CLASS A 30 DS,A (dB) reduction Speech level reduction DS,A (dB) is measured using ISO 23351-1. Pod can be placed next to workspaces without compromising privacy
Sound masking	FRAMERY OFFICE SOUND MASKING SYSTEM™ A pre-fitted sound masking system improves the soundscape of the office outside the pods with an effective radius of 5 m / 16 ft
Ventilation	MAXIMUM AIRFLOW 100 l/s, 212 CFM (360.2 m³/h) DEFAULT AIRFLOW 78 l/s, 165 CFM (280 m³/h) when in use. After use, the pod refreshes itself with a higher ventilation speed. STANDBY MODE 40 l/s, 85 CFM, (144 m³/h) ADJUSTABLE DIRECTIONAL AIRFLOW Choose between direct and indirect airflow
Lighting	CEILING LIGHT Color temperature 4000K, illuminance up to 500lux on the table top. VIDEO LIGHT Color temperature 4000K, illuminance up to 350lux on the user's face. PRE-SET LIGHTING MODES Standard mode & Video call mode. Lighting can also be adjusted also manually
Presence detection	SENSOR TECHNOLOGY mmWave radar
Dimensions	EXTERIOR with air filter housing 232.9 × 235.2 × 129.2 cm / 91.7 × 92.6 × 50.9 in (h, w, d) DOORWAY 209.7 × 96.6 cm / 82.6 × 38 in (h, w) WEIGHT 520 kg / 1146.4 lb (Framery Four Base 460 kg / 208.7 lb) THRESHOLD 1.25 cm / 0.5 in
Touchscreen location	On the table (Framery Four Base: on the wall, right side)
Connectivity	Framery smart pods gather anonymous occupancy data, measuring when and how often spaces are used. Users in the space cannot be identified and no personally identifiable data is collected. The anonymous data is transferred via built-in 4G connectivity, or through a Wi-Fi connection and compiled and shown in the Framery Connect platform. WLAN Wi-Fi 802.11 a/b/g/n/ac 2.4&5 GHz

DIMENSIONS / MAIN VIEW

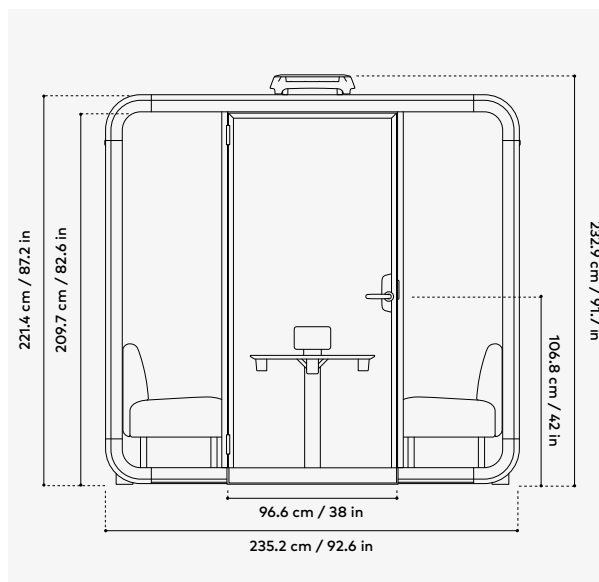
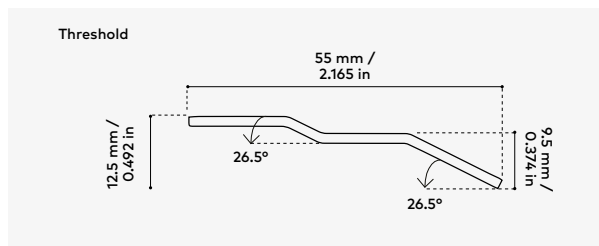
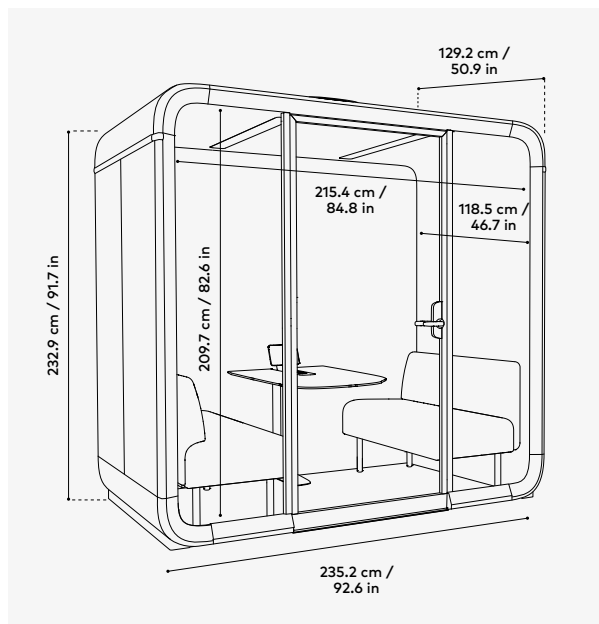

Framery Four is UL GREENGUARD GOLD certified



Framery Four shipped in North America is UL 962 listed

Framery Four / Technical specifications

MATERIALS

Exterior & structure	EXTERIOR PANELS Powder coated matt steel panels. FRAMES Structure matt black aluminum DOOR FRAME Structure matt black aluminum GLASS Sound control laminated glass (4 + 4 mm / 0.16 + 0.16 in) CHASSIS Light steel and PET sound-absorbing structure HANDLE Custom-designed black metal
Interior materials	INTERIOR PANELS PET sheets laminated with recycled polyester fabric. UPHOLSTERY FABRIC Gabriel Tonal. CARPET Antistatic and stain resistant low loop pile carpet CUSHIONS Gabriel Capture. TABLE Table top is birch plywood laminated with white, black anti-fingerprint, or oak veneer TABLE LEG Structure black metal
Seating materials	UPHOLSTERY FABRIC Gabriel Select FABRIC COMPOSITION 85 % New Zealand wool / 15 % Polyamide
Furniture dimensions	TABLE 70.6 cm × 90 cm / 27.8 × 35.4 in (w, d) Fixed height from floor 71.9 cm / 28.3 in MAX LOAD FOR THE TABLE 60 kg / 131 lb SOFA 110 × 60.5 cm (w, d) / 43.3 in × 23.8 in. Fixed seating height from floor 47 cm / 18.5 in (backrest height cm 78,5 / 30.9 in) MAX LOAD FOR SOFA 408 kg / 900 lb
Optional accessories	WHITEBOARD 102.2 x 112 cm / 40.2 x 44 in (h, w) ROTATING MONITOR ARM Max monitor size 24" - 27". Max weight 15 kg / 33 lbs with a flat 75 x 75 or 100 x 100 center-positioned VESA mounting surface. Monitor not included. COAT HOOKS Structure black metal CUSHIONS Gabriel Capture – 85 % New Zealand wool / 15 % Polyamide EXTERIOR TABLET MOUNT With easy set-up SMART LOCK Locking capability with different entry methods

DIMENSIONS / TOP VIEW

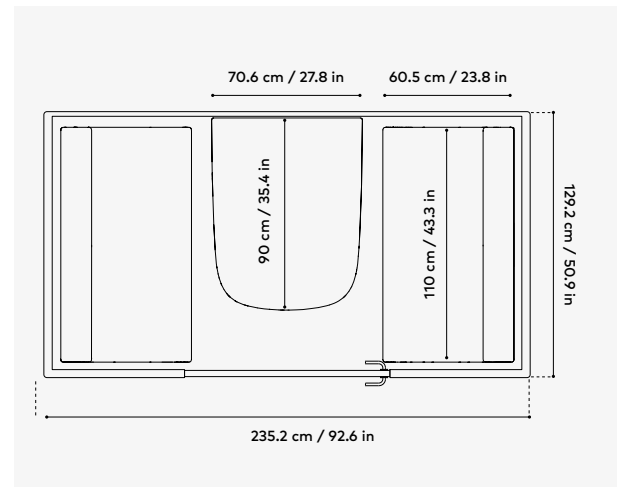

SAFETY

Fire safety	No fire hazardous materials are used in Framery pods. The fire safety of all surface materials, upholstery and acoustics materials of our products are tested and classified by either national or international standards. Framery provides additional safety measurements to adhere to local regulatory requirements
Seismic safety	A seismic anchoring kit for a pod is available for the seismic regions. The kit consists of brackets that further reinforce the pod structure to withstand heavy seismic forces

Framery Four / Technical specifications

POWER AND SPACE REQUIREMENTS

Power

FRAMERY FOUR ESSENTIALS OUTLETS

4 x under-table power outlets, 2 x USB-C PD charge ports (65 W). Optional: 2 x under-table power outlets (included with the monitor arm). Optional in-table outlets (max. 2): 0-1 x HDMI port, 0-2 x LAN ports (with cables)

FRAMERY FOUR LITE OUTLETS

4 x under-table power outlets. Optional: 2 x under-table power outlets (included with the monitor arm). Optional in-table outlets (max 4): 0-2 x USB-C PD charge ports (65 W), 0-1 x HDMI port, 0-4 x LAN ports (with cables)

FRAMERY FOUR BASE OUTLETS

4 x power outlets (2 x power outlets on each side of the pod). Optional outlets (max 4): 0-2 x USB-C PD charge ports (65 W), 0-4 x LAN ports (with cables)

POWER CONSUMPTION Default settings 52W. Highest settings 115W. Standby mode 20W. **INPUT** 100-240 VAC, 10 A*, 50-60 Hz. **OUTPUT AC (POWER OUTLET)** 100-240 VAC (8 A max) 50-60 Hz. **OUTPUT USB-C PD CHARGE PORT** 65W

*North America: NEMA 5-15P (120v 3-prong)

*India: 16A

Space requirements

DOOR SWING ANGLE 180°

Door handedness

Left-handed by default (can also be installed right-handed)

Movability

Relocate the pod without the need for disassembly by adding casters with a movability kit. Compatible with Framery Four and Six. The kit is reusable. Multiple pods can be moved with one kit

SHIPPING CRATE DIMENSIONS

Crate 1

SIZE 226 x 75 x 138 cm / 90 x 29.5 x 54.3 in (l, w, h). **WEIGHT** 278 kg / 612.9 lb

Crate 2

SIZE 224 x 74 x 114 cm / 88.2 x 29.1 x 44.9 in (l, w, h). **WEIGHT** 395 kg / 870.8 lb

Crate 1 is stacked on top of Crate 2.

DIMENSIONS / POWER CORD SPECIFICATIONS

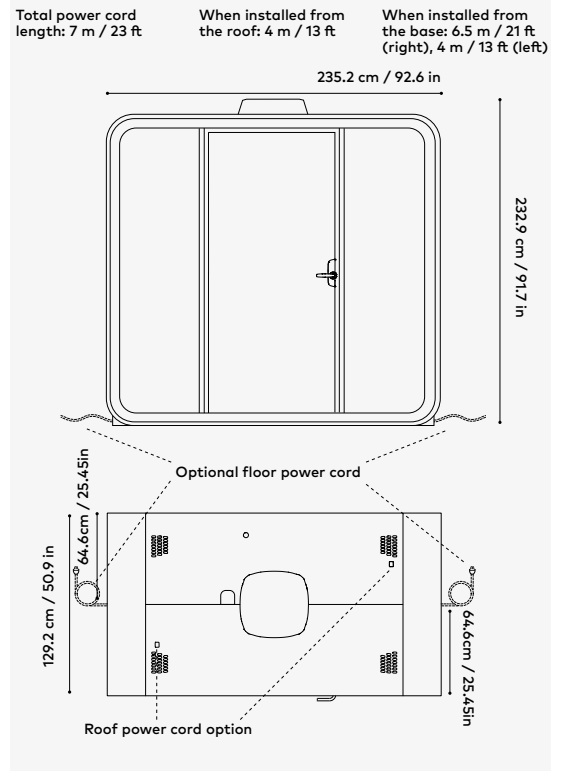

See all pod dimensions.



For the doers,
leaders, thinkers,
dreamers, creators,
teams, pioneers
and innovators.
**For people who
get it done.**