

Framery One™



The smart and soundproof office pod
shaping the workplace of tomorrow

framery



Framery One is a smart, spacious, one-person workstation designed for video calls and focus work. Contemporary design and advanced technology characterize every detail of this comfortable and versatile workspace. This soundproof office pod features world-class sound insulation, industry-leading ventilation, and echo-free acoustics so you can focus on your work and connect online with people anywhere.

Framery One / Product highlights



Workdays that flow with ease

Framery One has been purposefully designed to make your workdays flow easier. Automatically reserve a vacant pod by stepping inside, or book it in advance from the Framery app. Extend your reservation directly from the pod's touchscreen, or adjust your booking through the app.



Privacy you can trust

A-Class soundproofing assures that Framery pods can be placed next to workstations without causing noise distractions to the person in the pod or to the people outside. And echo-free interior acoustics make Framery One a private, comfortable place for work and video calls.



Airflow that keeps you fresh

Stay fresh and focused with efficient airflow. Enhanced ventilation fully refreshes the air every minute. The ventilation can be easily adjusted to the user's preferences through the pod's touchscreen display with a single touch.



Lighting that makes you feel good

Automated dual-lighting sources adapt to your needs, with preset lighting options to choose between work or video modes. Video-optimized lighting helps you shine on video calls. Adjustments can be made quickly and easily through the touchscreen display.

Framery One / Tech features



1. A-CLASS SOUNDPROOFING

Guaranteed privacy with an industry leading Class A speech level reduction of 30dB and one of the industry's top ISO 23351-1 ratings for office phone booths.

2. ADJUSTABLE VENTILATION

Proprietary design enables unparalleled ventilation with maximum airflow of 26 l/s – surpassing industry standards around the world.

3. OPTIMIZED LIGHTING

Dual adjustable 4000K LED light sources allow you to seamlessly switch between video or work modes – or make manual adjustments for personalized illumination.

4. AUTOMATED WALK-IN RESERVATIONS

Step inside the pod to create an automatic walk-in reservation – or easily find and book Framery One through the Framery app. Adjust your booking from the mobile application, or directly from inside the pod.

5. BUILT-IN 4G CONNECTION

Framery smart pods come with built-in 4G connection enabling over the air software updates and keeping your pods connected to your calendar.

6. INTUITIVE UI

A high-resolution touchscreen makes it easy to control pod settings, adjust lighting and airflow, and manage calendar reservations.

7. AUTOMATIC UPDATES

A built-in 4G connection enables automatic over-the-air software updates – initiated instantly and silently in the background.

8. OCCUPANCY INDICATION

The side-mounted occupancy lights show at a glance whether the pod is free or already in use. The pod's usage data is gathered and visualized in Framery Connect™ to help ensure you have the right number pods, and that they are placed correctly in your office.

9. FRAMERY CONNECT™

Gain insights from occupancy data, initiate advanced bookability functionalities, and connect your Framery One to the entire office to get valuable usage data needed to improve the layout and efficiency of your workplace.

10. BOOKABLE PODS

Make your smart pod bookable like any meeting room. The pod's touchscreen will show reservations and you can manage them on the spot.

Framery One / Design details

Contemporary design and advanced technology characterize every detail of this comfortable and stylish soundproof pod that is built sustainably and engineered to last. Framery One is available in three distinct layouts, each designed to support a different way of working. Whether you need ergonomic adjustability, relaxed comfort, or open flexibility, there's a configuration to match your workday rhythm.



Ideal for tasks that require extended focus, Framery One is available with an electric work desk, a built-in height-adjustable stool, and dual footrests to support ergonomic working positions, and allow users to fine-tune their setup for comfort and concentration.



For more relaxed experience, an optional built-in sofa and curved desk create a comfortable, informal workspace that is well-suited for virtual meetings, solo work, or quiet moments between tasks. The table can be upgraded to an electric work desk.



The exterior occupancy lights show at a glance whether the pod is available or already taken.

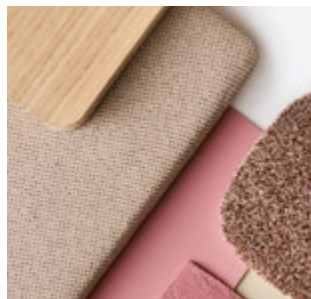

Customize your pod to fit your workplace with over 3000 combinations of colors, fabrics, and high-quality materials to choose from.

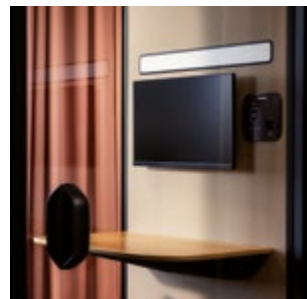

An optional monitor wall mount lets you add a full-sized display for additional flexibility.

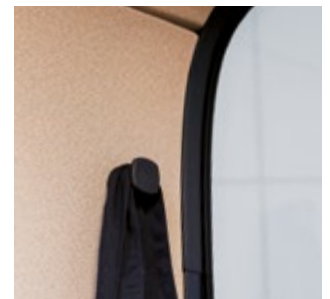

Convenient outlets and a coat hook are provided to accommodate all your office accessories.

Framery One / Colors and finishes



EXTERIORS

	White (Standard) RAL 9016 Ultramatt
	Black (Standard) RAL 9005 Ultramatt
	Gray (Standard) S 7500 - N Ultramatt
	Navy S 7020 - R90B Ultramatt
	Sand S 2010 - Y20R Ultramatt
	Powder Blue 3421-R86B Ultramatt
	Winter Moss S 7010-G10Y Ultramatt
	Blush 2728-R01B Ultramatt

CARPETS

	Light Gray (Standard) Fletco carpets
	Dark Blue Fletco carpets
	Champagne Fletco carpets
	Grape Fletco carpets





TABLE TOPS

	White (Standard) White laminate
	Black Black Laminate with anti-fingerprint surface
	Oak Veneer

SEATING FABRICS

	Graphite (Standard) Select #60051 Gabriel
	Dark Blue Select #66144 Gabriel
	Grape Select #61190 Gabriel
	Rose Select #65117 Gabriel
	Powder Blue Select #67098 Gabriel
	Beige Select #61184 Gabriel
	Green Select #68209 Gabriel
	Mustard Select #62098 Gabriel

INTERIORS

	Pure Gray (Standard) Tonal #60123 Gabriel
	Arctic Blue Tonal #66185 Gabriel
	Sand Tonal #61180 Gabriel
	Rouge Tonal #64210 Gabriel

Design your own
on our website



MATERIALS AND FINISHES



EXTERIOR PANELS made from steel feature a powder-coated matt finish. The lightweight panels are joined together seamlessly, with elegant curves that create a timeless design.



INTERIOR PANELS made from high-quality and recycled polyester have a vibrant and dynamic look thanks to the mix of the two-colored fabric.

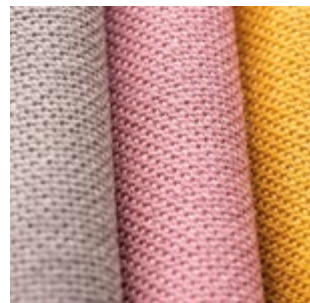

SEATING MATERIALS are a blend of superior New Zealand wool and polyamid that form a soft and rich texture. The extremely durable fabrics are both dirt and water repellent.



CARPET FLOORING is anti-static, stain resistant, and durable, giving the pod an overall soft look and finish.

Framery smart office solutions / Make any space smart with Framery

Framery smart office solutions are workplace tools that help workplace managers make data-driven office design decisions and access workplace insights through intuitive dashboards. The seamless room booking solutions deliver a premium employee experience.

Pair the solutions with Framery smart pods, or turn any office space into a smart workspace.



NEW

Framery Room Sensor™

WORKPLACE MANAGEMENT Utilize private and advanced occupancy and people-counting data to create the ideal work environment for both focused solo work and collaboration. Identify underutilized and improperly used spaces to make precise layout adjustments, effectively cutting costs and maximizing real estate ROI.

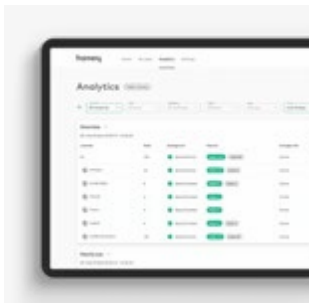

Framery Connect™

WORKPLACE MANAGEMENT
A smart platform for workplace management.

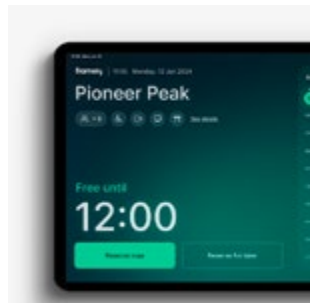

Framery Room Display™

ROOM BOOKING SOLUTIONS
See availability and book any room with ease.



Framery Space Overview™

ROOM BOOKING SOLUTIONS
Shows real-time availability of nearby spaces.

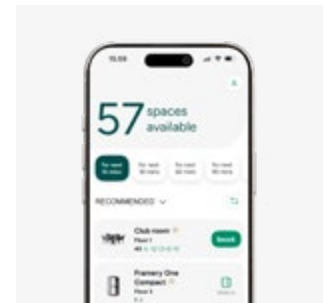

Framery App™

ROOM BOOKING SOLUTIONS
Find and book spaces in seconds.

Accessory kits

Add a complete hardware kit for your Framery Room Display and Space Overview, or use your own equipment.

Automatic updates

Instantly receive software updates through your smart pod's 4G connection to enable the future developments.

Privacy assured

No identifiable user data is collected —only workspace occupancy information is tracked.

FREE SUBSCRIPTION FOR NEW SMART POD OWNERS

Receive a complimentary 3-month Plus subscription, giving access to all our smart office solutions.

Read more



Framery smart pods / Environmental data sheet

Made with waste – not to waste.

The “fast furniture” trend means 80% of office furniture ends up in landfills. We wanted to create a pod that’s part of the solution, not the problem. That’s why we build our pods optimizing the use of recycled materials, and more importantly, design them to last decades. Plus, our smart office solutions help maximize space usage.

Framery measures its impact holistically and there are three primary focus areas: Climate and Environment, People and Society, and Fair Business. We annually publish the sustainability report and update our Environmental Product Declarations (EPDs), which are based on third-party reports and validation. Additionally, Framery has a positive net impact ratio meaning that the company creates more value compared to the resources it uses.

UN Global Compact & Science Based Targets initiative

We participate in the UN Global Compact as well as the Science Based Targets initiative and have set emission-reduction targets aligned with the goal of limiting global warming to 1.5°C compared to pre-industrial levels. We have also set a target to reduce our emissions per pod by more than 50% by 2028 compared to 2023.

Material and environmental efficiency

We aim to reduce our reliance on virgin materials by optimizing recycled whenever possible, while balancing that goal with

material availability and ensuring our pods remain durable and high-quality.

Our smart pods feature:

- interior carpet with 20% recycled content
- interior panels with 60-70% recycled material
- sound-absorbing panels with 50-60% recycled content
- glass typically with 20-33% recycled content
- steel and aluminum with 0-30% recycled content (due to global demand)

The material efficiency rate describes the volume of waste in relation to the input materials. In 2024, our material efficiency reached 95.7% at our factory. More than half of the waste generated is bio-based waste that is directed to incineration with energy recovery. We don’t use any water in our manufacturing processes.

Sustainability throughout the pod’s lifecycle

Leveraging their smart features and connectivity, even after manufacturing, our smart pods can receive over-the-air (OTA) updates that further improve their sustainability. We have already released an OTA update that automatically reduced the lifetime electricity usage by approximately 30% which contributed to a lower carbon footprint for all manufactured and connected smart pods globally—no input was required from the smart pod owners.

The most efficient pod is the one used to its fullest extent and our smart office solutions help customers to maximize pod utilization. From ensuring pods are easy to book and comfortable to use, to optimizing their occupancy, our range of digital products helps ensure a long, productive life for our smart pods.

The majority of the pods’ components are modular, refurbishable and easily replaceable to ensure decades of use. Because the smart pods are so durable and easy to relocate, there is also a second-hand market for our pods.

Certificates and studies available:

- Life Cycle Assessment (LCA)
- Environmental Product Declarations (EPDs)
- Health Product Declarations (HPD)
- Declare labels
- Möbelfakta
- UL GREENGUARD Gold
- Contribution to green building certifications such as LEED certifications, BREEAM, SKA and WELL



Framery has been awarded with a Silver Medal sustainability rating from Ecovadis sustainability – placing us among the top 8% percent of companies assessed in the past year.



Framery holds the Certified Autism Resource (CAR) designation, earned after an IBCCES expert board certified its product aligns with competency areas to meet the needs of individuals with autism.



Find the sustainability report and the smart pods' EPDs by scanning the QR code or go to framery.com.

Framery One™

Technical specifications

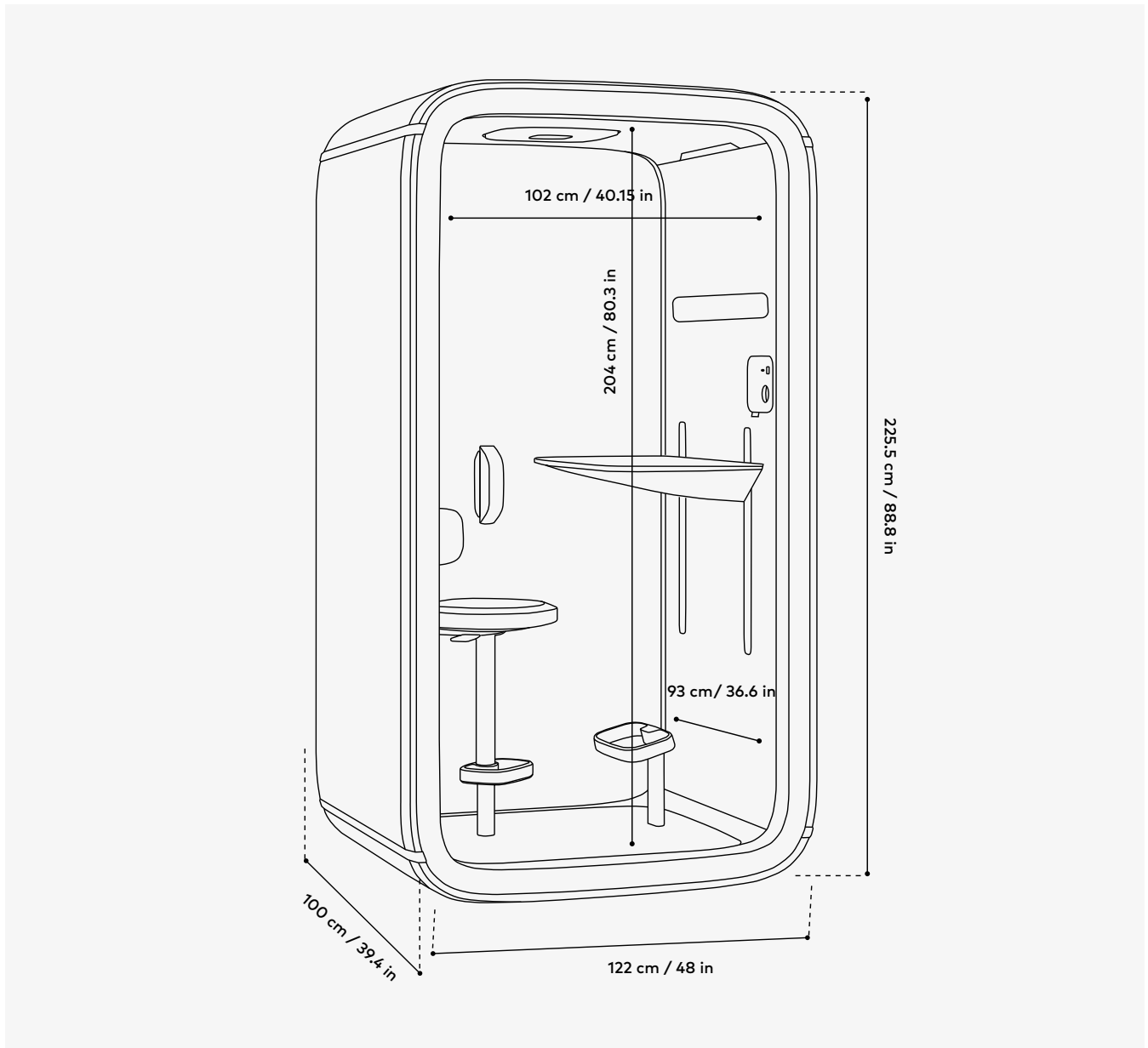

Performance

Speech level reduction: 30dB
Max airflow: 26 l/s
Low energy consumption: 28W

Sustainable design

Built to last for decades
Light-weight product structures
Refurbishable & movable

Connectivity

Built-in 4G connection
Automatic software updates
Framery Connect digital services

Framery One / Technical specifications

OVERVIEW

Soundproofing	CLASS A 30 DS,A (dB) reduction Speech level reduction DS,A (dB) is measured using ISO 23351-1. Pod can be placed next to workspaces without compromising privacy.
Ventilation	DEFAULT AIRFLOW 26 l/s, 55 CFM (94 m³/h). Airflow can be adjusted manually. After use, the pod refreshes itself with a higher ventilation speed. STANDBY MODE 7 l/s, 15 CFM, (25 m³/h)
Lighting	CEILING LIGHT Color temperature 4000 K, illuminance up to 500 lux on the tabletop. VIDEO LIGHT Color temperature 4000 K, illuminance up to 400 lux on the user's face. PRE-SET LIGHTING MODES Standard mode & Video call mode. Lighting can also be adjusted manually.
Presence detection	SENSOR TECHNOLOGY Ultrasonic sensor
Dimensions	EXTERIOR 225.5 x 122 x 100 cm / 88.8 x 48 x 39.4 in (h, w, d) WITH CASTERS Additional 3 cm / 1.18 in (h) WITH AIR FILTER additional 6.5 cm / 2.56 in (h) WITH SEISMIC KIT additional 2 cm / 0.78 in (h) DOORWAY 204 x 101.5 cm / 80.3 x 40 in (h, w) WEIGHT 357 kg / 787 lb (Framery One Lounge: 370 kg / 815.7 lb) THRESHOLD 11 cm / 4.35 in (with casters 12.3 cm / 4.85 in)
Connectivity	Framery smart pods gather anonymous occupancy data, measuring when and how often spaces are used. Users in the space cannot be identified and no personally identifiable data is collected. The anonymous data is transferred via built-in 4G connectivity, and compiled and shown in the Framery Connect platform.

DIMENSIONS / MAIN VIEW

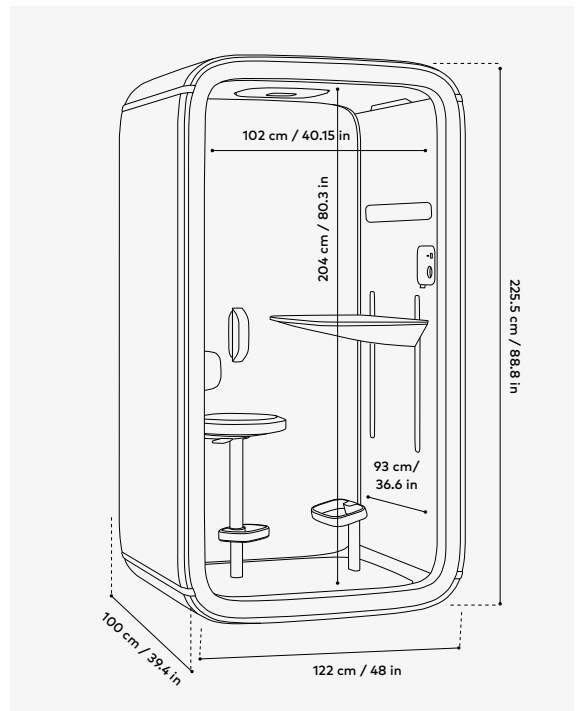

DIMENSIONS / HEIGHT ADJUSTABLE SEAT AND TABLE / FRONT VIEW

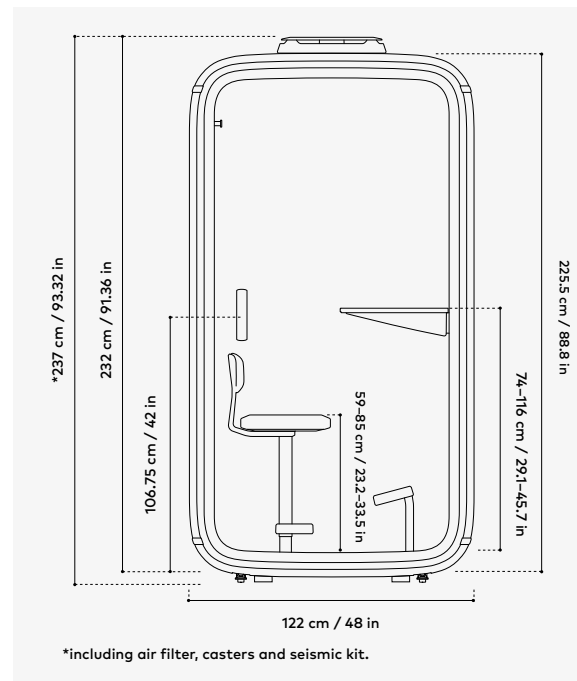

Framery One is
UL GREENGUARD GOLD
certified



Framery One shipped in North
America is UL 962 listed

Framery One / Technical specifications

MATERIALS

Exterior & structure

EXTERIOR PANELS Powder coated matt steel panels
FRAMES Structure matt black frames made from steel & aluminum
DOOR FRAME Matt black composite structure
GLASS Sound control laminated glass (4 + 4 mm / 0.16 + 0.16 in.)
CHASSIS A sandwich element chassis, made of sheet metal & recycled acoustic foam
HANDLE Black cast aluminum

Interior materials

INTERIOR PANELS PET sheets which are laminated with recycled polyester fabric
UPHOLSTERY FABRIC Gabriel Tonal
CARPET Antistatic and stain resistant low loop pile carpet
TABLE Table top is birch plywood laminated with white, black anti-fingerprint, or oak veneer. The table bottom is black thermoformed felt

Seating materials

UPHOLSTERY FABRIC Gabriel Select
FABRIC COMPOSITION 85 % New Zealand wool / 15 % Polyamide
STOOL & FOOTREST Steel, aluminum & plastic (Carpet also included for the Framery One Lounge footrest)

Furniture dimensions

TABLE SIZE 76.5 x 46 cm / 30.1 x 18 in (w, d)
TABLE HEIGHT 74–116 cm / 29.1–45.7 in (Framery One Lounge with fixed table 88 cm / 34.6 in)
MAX LOAD FOR THE TABLE 50 kg / 110 lb
SEAT SIZE 38 x 38 cm / 15 x 15 in (d, w) (Framery One Lounge 40.2 x 60.7 cm / 15.8 in x 23.9 in)
SEAT HEIGHT 59–85 cm / 23.2–33.5 in (Framery One Lounge 62 cm / 24.4 in)
MAX LOAD FOR THE SEAT 135 kg / 300 lb (Framery One Lounge 200kg / 441 lb)

Optional accessories

MONITOR WALL MOUNT Maximum monitor size 24". Maximum weight 5 kg / 11 lbs with flat VESA 100 x 100 mounting surface. Monitor not included.

SHIPPING CRATE

Dimensions

229 x 131 x 88 cm / 90.15 x 51.6 x 34.6 in (Framery One Lounge also includes a second crate 80 x 60 x 70 cm / 31.5 x 23.6 x 27.6 in.)

Weight

430 kg / 948 lb (Framery One Lounge 464 kg / 1023 lb). Crates can be stacked (max 3 boxes).

DIMENSIONS / HEIGHT ADJUSTABLE SEAT AND TABLE / TOP VIEW

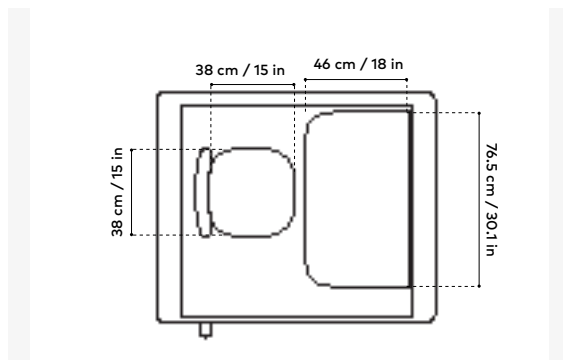

DIMENSIONS / LOUNGE SEAT AND FIXED TABLE / FRONT VIEW

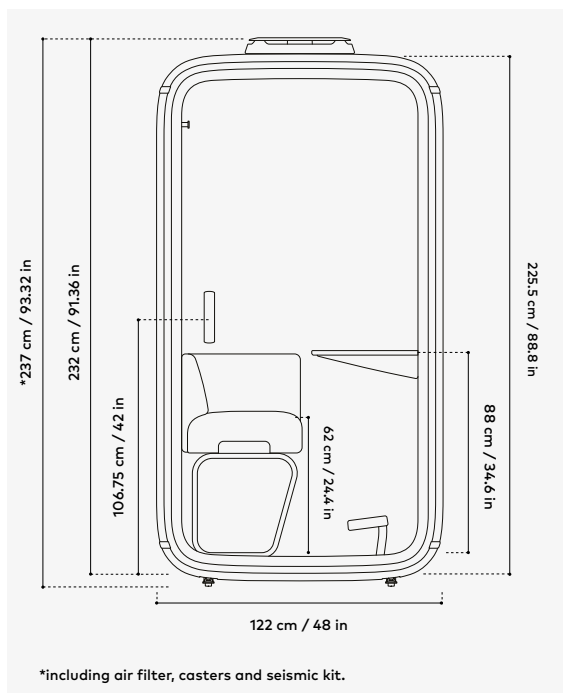

DIMENSIONS / LOUNGE SEAT AND FIXED TABLE / TOP VIEW

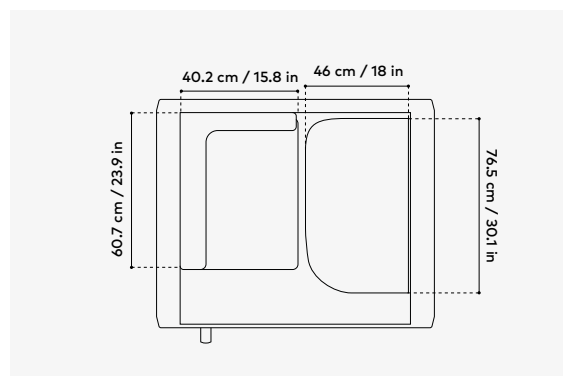

Framery One / Technical specifications

POWER AND SPACE REQUIREMENTS

Power	OUTLETS 1 × power outlet, 1 × USB-C charge port (15W) Optional: 1 × LAN port (with cable)
	POWER CONSUMPTION Default settings 28W. Highest settings 37W Standby mode 6W
	INPUT 100–240 VAC, 10 A*, 50–60 Hz
	OUTPUT AC (POWER OUTLET) 100–240VAC, 6.6A, 50–60 Hz

OUTPUT USB-C CHARGE PORT 15W

*North America: NEMA 5-15P (120v 3-prong)
*India: 16A

Space requirements	DOOR SWING ANGLE 90°
Door handedness	Right-handed by default (can also be installed left-handed)
Movability	Relocate the pod without the need for disassembly by adding casters (optional). Levelling guides must be lifted when moving the pod, and lowered when placed in position.

SAFETY

Fire safety	No fire hazardous materials are used in Framery pods. The fire safety of all surface materials, upholstery and acoustics materials of our products are tested and classified by either national or international standards. Framery provides additional safety measurements to adhere to local regulatory requirements.
Seismic safety	A seismic anchoring kit for a pod is available for the seismic regions. The kit consists of brackets that further reinforce the pod structure to withstand heavy seismic forces.

DIMENSIONS / POWER CORD SPECIFICATIONS

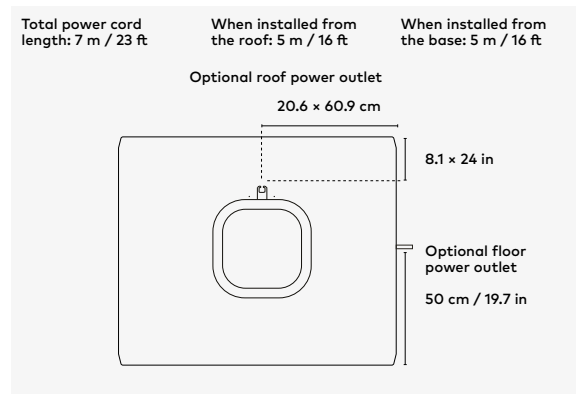

See all pod dimensions.



For the doers,
leaders, thinkers,
dreamers, creators,
teams, pioneers
and innovators.
**For people who
get it done.**