

# Framery Six™



The smart and soundproof office meeting room  
shaping the workspace of tomorrow

**framery**



Framery Six is a smart meeting room for up to 6 people. This multifunctional soundproof meeting space is tailored for collaborative teamwork and enhanced for face-to-face and hybrid brainstorming sessions. With finely-tuned acoustics and top-notch soundproofing, it ensures privacy during discussions and virtual meetings. Framery Six's adaptive ventilation and automated lighting ensure your team can focus on what really matters and have a successful workday.

## Framery Six / Product highlights



### Workdays that flow with ease

Framery Six has been purposefully designed to make your workdays flow better. Find and book the pod in advance or on-the-fly from the Framery app. Or step inside and the pod automatically creates a reservation for you. Extend your reservation directly from the pod's touchscreen, or adjust your booking through the app.



### Privacy you can trust

The fine-tuned acoustic structure provides A-Class soundproofing that allows the pod to be placed next to workstations without causing noise distractions to the user or to those outside of the pod. And echo-free interior acoustics make the pod a private, comfortable place for work and video calls.



### Airflow that keeps you fresh

The pod recognizes when it's occupied, senses the number of people, the temperature and humidity of the surroundings, and triggers adjustments to the airflow accordingly. Enhanced ventilation fully refreshes the air every minute, and ventilation can be easily adjusted through the pod's touchscreen.



### Lighting that makes you feel good

Multiple automated light sources adapt to your needs, with preset lighting options to choose between work or video modes. Video-optimized lighting helps you shine on video calls. Adjustments can be made quickly and easily through the touchscreen display.

## Framery Six / Tech features



### 1. A-CLASS SOUNDPROOFING

Guaranteed privacy with fine-tuned Class A speech level reduction of 30dB – and the industry's top ISO 23351-1 rating for office phone booths.

### 2. FRAMERY OFFICE SOUND MASKING SYSTEM™

The embedded system is based on patent-pending technology that reduces noise distractions and protects speech privacy in office environments by adding a subtle, unobtrusive background sound outside of the pod. This ambient background noise, similar to air flow, is specifically designed to blend in with the office's noise atmosphere – making sounds less intelligible and therefore less distracting.

### 3. ADAPTIVE VENTILATION

Proprietary design enables unparalleled ventilation with maximum airflow of 187 l/s – surpassing industry standards around the world.

### 4. TEMPERATURE & HUMIDITY SENSORS

Sensors inside the pod recognize the temperature and humidity of the office environment, and automatically optimize the airflow accordingly.

### 5. AUTOMATIC LIGHTING MODES

Multiple adjustable 4000K LED light sources allow you to seamlessly switch between video or work modes – or make manual adjustments for personalized illumination.

### 6. 8-INCH TOUCHSCREEN

An intuitive, 8-inch high-resolution touchscreen makes it easy to control pod settings, adjust lighting and airflow, and extend calendar reservations effortlessly.

### 7. AUTOMATIC UPGRADES

A built-in 4G connection enables automatic over-the-air software updates – initiated instantly and silently in the background.

### 8. MMWAVE RADAR PRESENCE DETECTION

Millimeter-wave radar sensors immediately detect when someone enters or leaves the pod, allowing lighting and ventilation to adjust accordingly.

Occupancy data is gathered and displayed through Framery Connect to provide information about when the pod is being used the most.

### 9. FRAMERY CONNECT™

Gain insights from occupancy data, initiate advanced bookability functionalities, and connect your Framery Six to the entire office to get valuable usage data needed to improve the layout and efficiency of your workplace.

### 10. BOOKABLE PODS

Make your smart pod bookable like any meeting room. The pod's touchscreen will show reservations and you can manage them on the spot.

---

## Framery Six / Design details

Framery Six combines the best features of a larger meeting room in a convenient, modular package. The luxurious and spacious interior comes equipped with a proper-sized meeting table that can be complemented with your own choice of seats. The pod's low threshold enables easy access, and the minimalistic design approach uses carefully curated materials, making it a sustainable choice.



Framery Six is designed to bring teams together - whether you're meeting face-to-face or collaborating online. The space is tailored for collaborative teamwork, and enhanced for face-to-face and hybrid brainstorming sessions.

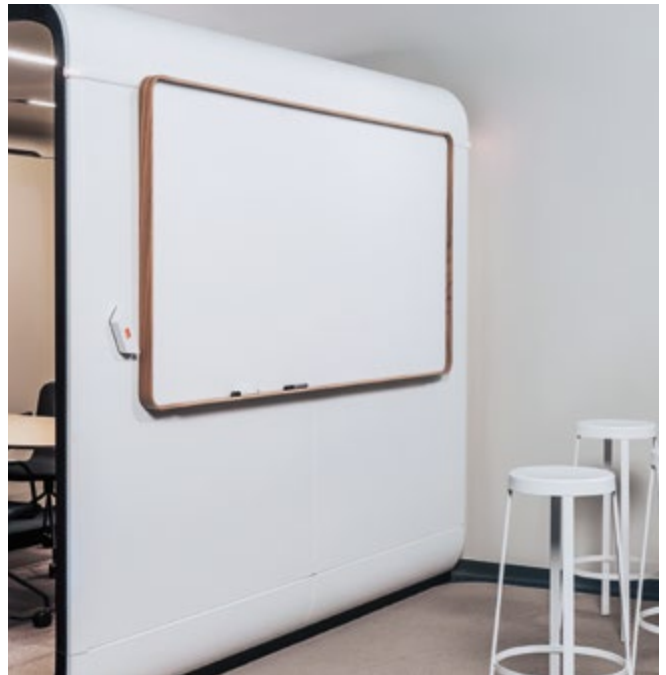

The optional gather zone outside of Framery Six creates an additional meeting area, featuring matching carpet and a convenient add-on rail where a whiteboard or additional display can be attached. This effectively doubles the amount of working space that Framery Six can offer.



The exterior occupancy lights show at a glance whether the pod is available or already taken.



The custom-designed table comfortably accommodates an entire team, and built-in power outlets and optional coat hooks support all your office accessories.

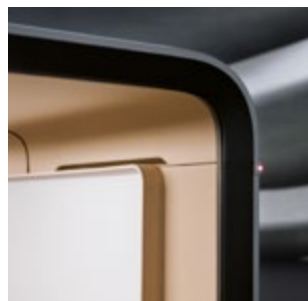

An optional interior whiteboard can be provided to make it even easier to collaborate participants during meetings.







Customize your pod to fit your workplace with hundreds of combinations of colors, fabrics, and high-quality materials to choose from.

# Framery Six / Colors and finishes

## EXTERIORS

	White (Standard) RAL 9016 Ultramatt
	Black (Standard) RAL 9005 Ultramatt
	Gray (Standard) S 7500 - N Ultramatt
	Navy S 7020 - R90B Ultramatt
	Sand S 2010 - Y20R Ultramatt
	Powder Blue 3421-R86B Ultramatt
	Winter Moss S 7010-G10Y Ultramatt
	Blush 2728-R01B Ultramatt



## INTERIORS

	Pure Gray (Standard) Tonal #60123 Gabriel
	Arctic Blue Tonal #66185 Gabriel
	Sand Tonal #61180 Gabriel
	Rouge Tonal #64210 Gabriel

## CARPETS

	Light Gray (Standard) Fletco carpets
	Dark Blue Fletco carpets
	Champagne Fletco carpets
	Grape Fletco carpets

## TABLE TOPS

	White (Standard) White laminate
	Black Black Laminate with anti-fingerprint surface
	Oak Veneer

Design your own  
on our website



## MATERIALS AND FINISHES



**EXTERIOR PANELS** made from steel feature a powder-coated matt finish. The lightweight panels are joined together seamlessly, with elegant curves that create a timeless design.



**INTERIOR PANELS** made from high-quality and recycled polyester have a vibrant and dynamic look thanks to the mix of the two-colored fabric.

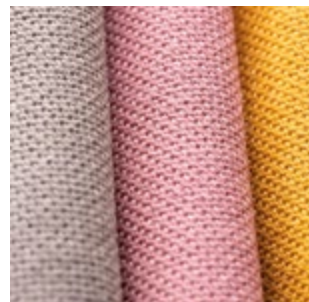

**SEATING MATERIALS** are a blend of superior New Zealand wool and polyamid that form a soft and rich texture. The extremely durable fabrics are both dirt and water repellent.



**CARPET FLOORING** is anti-static, stain resistant, and durable, giving the pod an overall soft look and finish.

---

## Framery smart office solutions / Make any space smart with Framery

Framery smart office solutions are workplace tools that help workplace managers make data-driven office design decisions and access workplace insights through intuitive dashboards. The seamless room booking solutions deliver a premium employee experience.

Pair the solutions with Framery smart pods, or turn any office space into a smart workspace.



NEW

### Framery Room Sensor™

**WORKPLACE MANAGEMENT** Utilize private and advanced occupancy and people-counting data to create the ideal work environment for both focused solo work and collaboration. Identify underutilized and improperly used spaces to make precise layout adjustments, effectively cutting costs and maximizing real estate ROI.

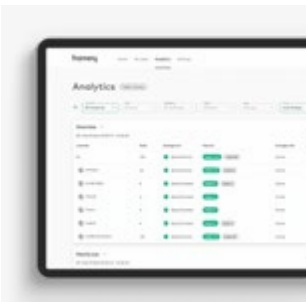

### Framery Connect™

**WORKPLACE MANAGEMENT**  
A smart platform for workplace management.



### Framery Room Display™

**ROOM BOOKING SOLUTIONS**  
See availability and book any room with ease.



### Framery Space Overview™

**ROOM BOOKING SOLUTIONS**  
Shows real-time availability of nearby spaces.

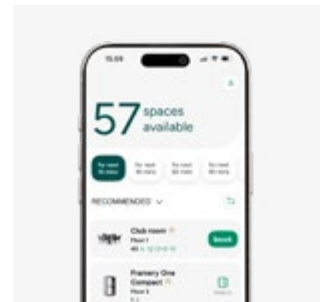

### Framery App™

**ROOM BOOKING SOLUTIONS**  
Find and book spaces in seconds.

### Accessory kits

Add a complete hardware kit for your Framery Room Display and Space Overview, or use your own equipment.

### Automatic updates

Instantly receive software updates through your smart pod's 4G connection to enable the future developments.

### Privacy assured

No identifiable user data is collected — only workspace occupancy information is tracked.

---

### FREE SUBSCRIPTION FOR NEW SMART POD OWNERS

Receive a complimentary 3-month Plus subscription, giving access to all our smart office solutions.

Read more



# Framery smart pods / Environmental data sheet

## Made with waste – not to waste.

The “fast furniture” trend means 80% of office furniture ends up in landfills. We wanted to create a pod that's part of the solution, not the problem. That's why we build our pods optimizing the use of recycled materials, and more importantly, design them to last decades. Plus, our smart office solutions help maximize space usage.

Framery measures its impact holistically and there are three primary focus areas: Climate and Environment, People and Society, and Fair Business. We annually publish the sustainability report and update our Environmental Product Declarations (EPDs), which are based on third-party party reports and validation. Additionally, Framery has a positive net impact ratio meaning that the company creates more value compared to the resources it uses.

## UN Global Compact & Science Based Targets initiative

We participate in the UN Global Compact as well as the Science Based Targets initiative and have set emission-reduction targets aligned with the goal of limiting global warming to 1.5°C compared to pre-industrial levels. We have also set a target to reduce our emissions per pod by more than 50% by 2028 compared to 2023.

## Material and environmental efficiency

We aim to reduce our reliance on virgin materials by optimizing recycled whenever possible, while balancing that goal with

material availability and ensuring our pods remain durable and high-quality.

Our smart pods feature:

- interior carpet with 20% recycled content
- interior panels with 60-70% recycled material
- sound-absorbing panels with 50-60% recycled content
- glass typically with 20-33% recycled content
- steel and aluminum with 0-30% recycled content (due to global demand)

The material efficiency rate describes the volume of waste in relation to the input materials. In 2024, our material efficiency reached 95.7% at our factory. More than half of the waste generated is bio-based waste that is directed to incineration with energy recovery. We don't use any water in our manufacturing processes.

## Sustainability throughout the pod's lifecycle

Leveraging their smart features and connectivity, even after manufacturing, our smart pods can receive over-the-air (OTA) updates that further improve their sustainability. We have already released an OTA update that automatically reduced the lifetime electricity usage by approximately 30% which contributed to a lower carbon footprint for all manufactured and connected smart pods globally—no input was required from the smart pod owners.

The most efficient pod is the one used to its fullest extent and our smart office solutions help customers to maximize pod utilization. From ensuring pods are easy to book and comfortable to use, to optimizing their occupancy, our range of digital products helps ensure a long, productive life for our smart pods.

The majority of the pods' components are modular, refurbishable and easily replaceable to ensure decades of use. Because the smart pods are so durable and easy to relocate, there is also a second-hand market for our pods.

## Certificates and studies available:

- Life Cycle Assessment (LCA)
- Environmental Product Declarations (EPDs)
- Health Product Declarations (HPD)
- Declare labels
- Möbelfakta
- UL GREENGUARD Gold
- Contribution to green building certifications such as LEED certifications, BREEAM, SKA and WELL



Framery has been awarded with a Silver Medal sustainability rating from Ecovadis sustainability – placing us among the top 8% percent of companies assessed in the past year.



Framery holds the Certified Autism Resource (CAR) designation, earned after an IBCCES expert board certified its product aligns with competency areas to meet the needs of individuals with autism.



Find the sustainability report and the smart pods' EPDs by scanning the QR code or go to framery.com.

# Framery Six™

## Technical specifications

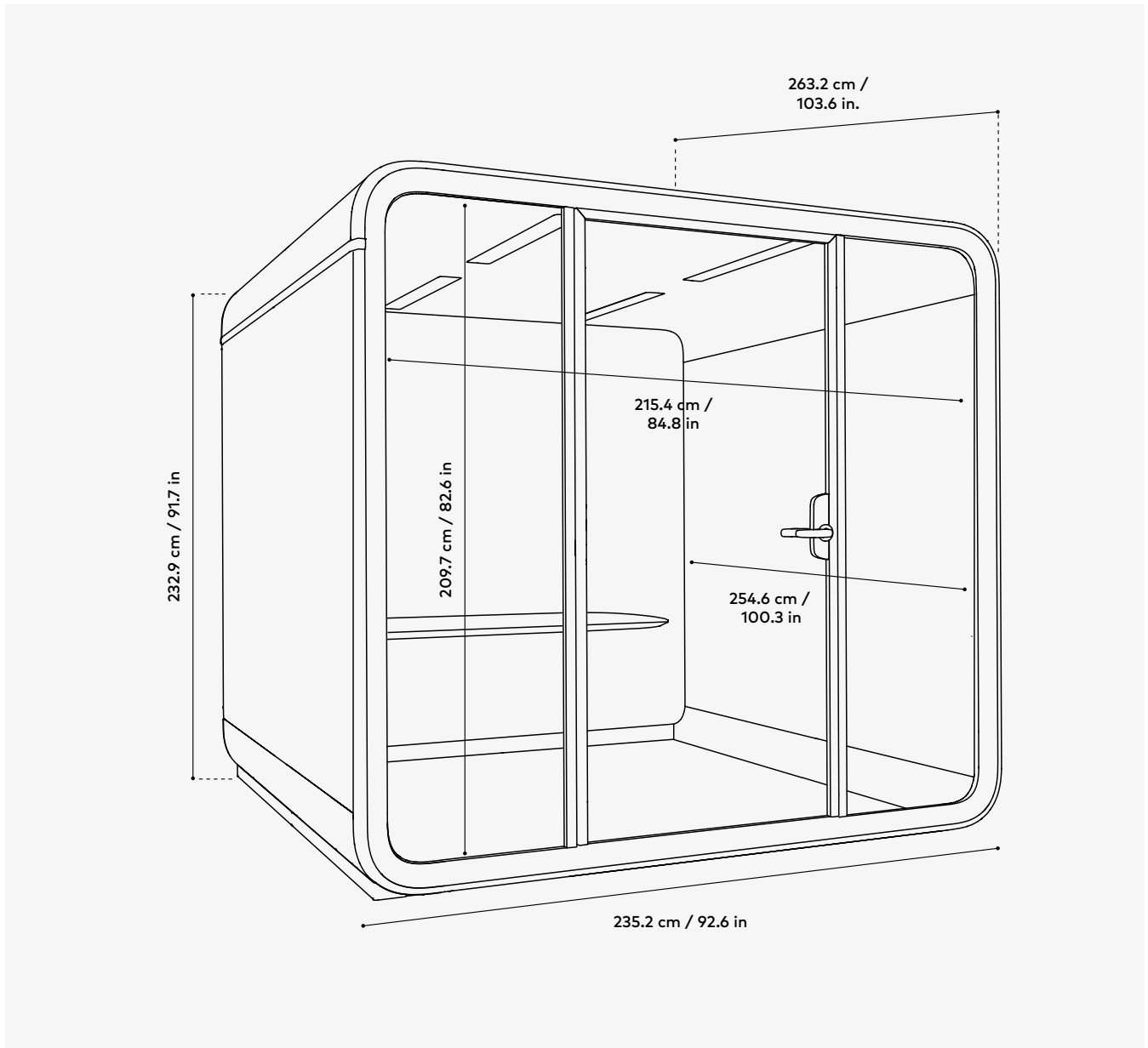

### Performance

Speech level reduction: 30dB

Max airflow: 187 l/s

Low energy consumption: 145W

### Sustainable design

Built to last for decades

Light-weight product structures

Refurbishable & movable

### Connectivity

Built-in 4G connection

Automatic software updates

Framery Connect digital services

# Framery Six / Technical specifications

## OVERVIEW

Soundproofing	<b>CLASS A 30 DS,A (dB) reduction</b> Speech level reduction DS,A (dB) is measured using ISO 23351-1. Pod can be placed next to workspaces without compromising privacy
Sound masking	<b>FRAMERY OFFICE SOUND MASKING SYSTEM™</b> A pre-fitted sound masking system improves the soundscape of the office outside the pods with an effective radius of 5 m / 16 ft
Ventilation	<b>MAXIMUM AIRFLOW 187 l/s, 397 CFM (674.6 m<sup>3</sup>/h)</b> <b>DEFAULT AIRFLOW 149 l/s, 316 CFM (536 m<sup>3</sup>/h)</b> when in use. After use, the pod refreshes itself with a higher ventilation speed. <b>ON STANDBY MODE 76 l/s, 161 CFM (274 m<sup>3</sup>/h)</b> <b>ADJUSTABLE DIRECTIONAL AIRFLOW</b> Choose between direct and indirect airflow
Lighting	<b>CEILING LIGHT</b> Color temperature 4000K, illuminance up to 500lux on the table top. <b>VIDEO LIGHT</b> Color temperature 4000K, illuminance up to 350lux on the user's face. <b>PRE-SET LIGHTING MODES</b> Standard mode & Video call mode. The lighting can also be adjusted manually
Presence detection	<b>SENSOR TECHNOLOGY</b> mmWave radar
Dimensions	<b>EXTERIOR</b> with air filter housing 232.9 × 235.2 × 263.2 cm / 91.7 × 92.6 × 103.6 in (h, w, d) <b>DOORWAY</b> 209.7 × 96.6 cm / 82.6 × 38 in (h, w) <b>WEIGHT</b> 718 kg / 1582.9 lb (Framery Six Base 693 kg / 1527.8 lb) <b>THRESHOLD</b> 1.25 cm / 0.5 in
Touchscreen location	On the table (Framery Six Base: on the wall)
Connectivity	Framery smart pods gather anonymous occupancy data, measuring when and how often spaces are used. Users in the space cannot be identified and no personally identifiable data is collected. The anonymous data is transferred via built-in 4G connectivity, or through a Wi-Fi connection and compiled and shown in the Framery Connect platform. <b>WLAN</b> Wi-Fi 802.11 a/b/g/n/ac 2.4&5 GHz

## DIMENSIONS / MAIN VIEW

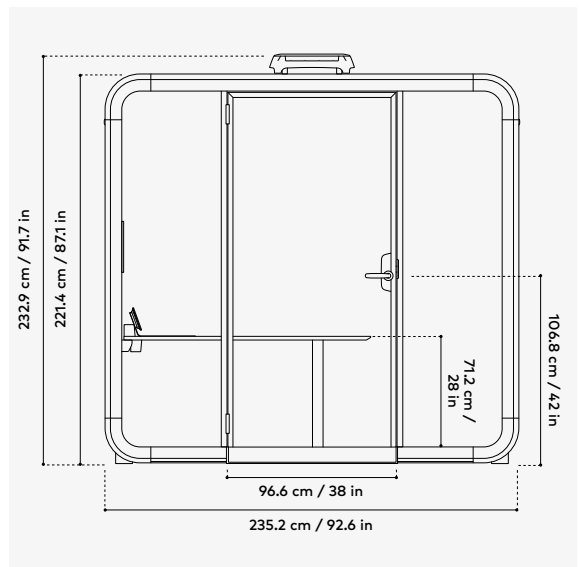
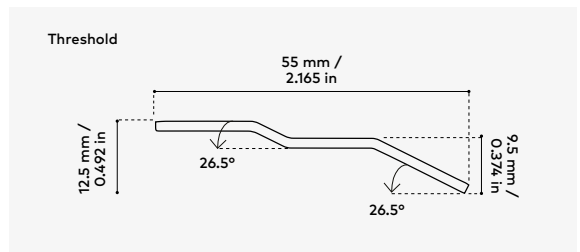
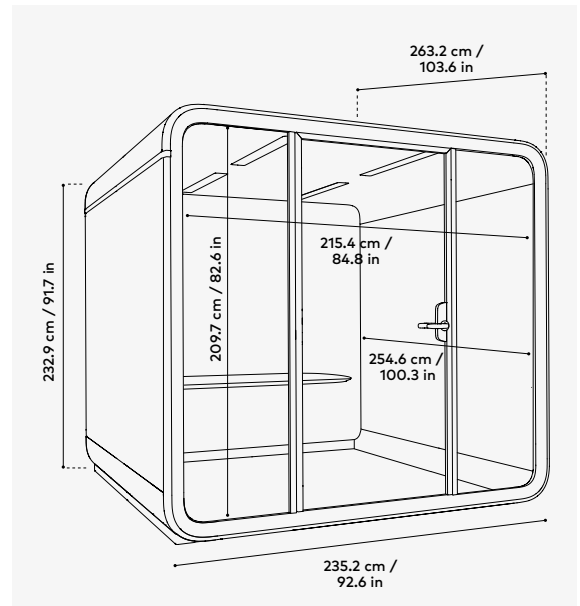

Framery Six is  
UL GREENGUARD GOLD  
certified



Framery Six shipped in North  
America is UL 962 listed

# Framery Six / Technical specifications

## MATERIALS

Exterior & structure	<b>EXTERIOR PANELS</b> Powder coated matt steel panels <b>FRAMES</b> Structure matt black aluminum. <b>DOOR FRAME</b> Structure matt black aluminum <b>GLASS</b> Sound control laminated glass (4 + 4 mm / 0.16 + 0.16 in) <b>CHASSIS</b> Light steel and PET sound-absorbing structure <b>HANDLE</b> Custom designed black metal
Interior materials	<b>INTERIOR PANELS</b> PET sheets laminated with recycled polyester fabric <b>UPHOLSTERY FABRIC</b> Gabriel Tonal <b>CARPET</b> Antistatic and stain resistant low loop pile carpet. <b>TABLE</b> Table top is birch plywood laminated with white, black anti-fingerprint, or oak veneer. <b>TABLE LEG</b> Structure black metal
Furniture dimensions	<b>TABLE</b> 94 cm x 140 cm / 37 in x 55.1 in (w, d) Fixed height from floor 71.2 cm / 28 in <b>MAX LOAD FOR THE TABLE</b> 60 kg / 131 lb
Optional accessories	<b>WHITEBOARD</b> 102.3 x 206.3 cm / 40.3 x 81.2 in (h, w) <b>MONITOR WALL MOUNT</b> Maximum monitor size 50". Maximum weight 30 kg / 66 lbs with flat VESA 100 x 100, 200 x 100, 200 x 200, 300 x 200, 300 x 300, 400 x 200, 400 x 300 or 400 x 400 mounting surface. Monitor not included. Possibility to mount on both walls. <b>COAT HOOKS</b> Structure black metal <b>EXTERIOR TABLET MOUNT</b> With easy set-up. <b>GATHER ZONE</b> Includes the same whiteboard and monitor wall mount as interior, and additional exterior carpet <b>SMART LOCK</b> Locking capability with different entry methods

## DIMENSIONS / TOP VIEW

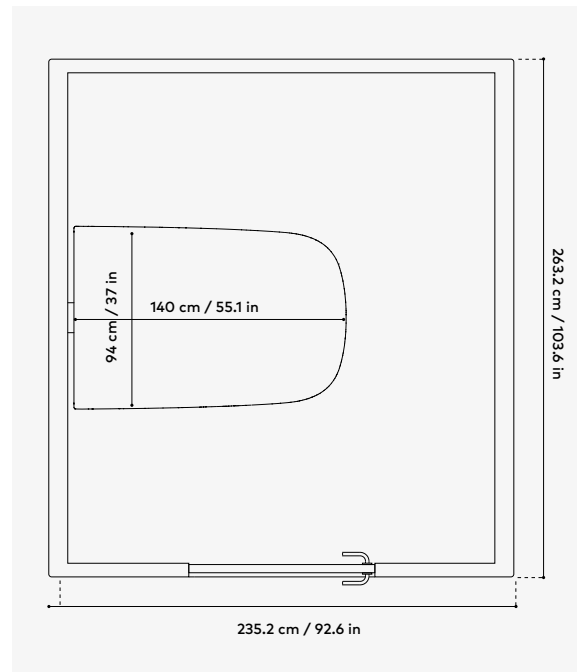

## SAFETY

Fire safety	No fire hazardous materials are used in Framery pods. The fire safety of all surface materials, upholstery and acoustics materials of our products are tested and classified by either national or international standards. Framery provides additional safety measurements to adhere to local regulatory requirements
Seismic safety	A seismic anchoring kit for a pod is available for the seismic regions. The kit consists of brackets that further reinforce the pod structure to withstand heavy seismic forces

# Framery Six / Technical specifications

## POWER AND SPACE REQUIREMENTS

### Power

#### FRAMERY SIX ESSENTIALS OUTLETS

2 x on-table outlets, 2 x under-table power outlets, 2 x in-table USB-C PD charge ports (65 W). Optional 2 x under-table power outlets. Optional in-table outlets (max 2) 0-1 x HDMI port, 0-2 x LAN ports (with cables)

**FRAMERY SIX LITE OUTLETS** 2 x on-table power outlets, 2 x under-table power outlets. Optional 2 x under-table power outlets. Optional in-table outlets (max 4) 0-2 x USB-C PD charge ports (65 W), 0-1 x HDMI port, 0-4 x LAN ports (with cables)

**FRAMERY SIX BASE OUTLETS** 4 x power outlets on the same side of the pod as the touchscreen. Optional outlets (max 4): 0-2 x USB-C PD charge ports (65 W), 0-4 x LAN ports (with cables)

**POWER CONSUMPTION** Default settings 145W. Highest settings 202W. Standby mode 28W. **INPUT** 100-240 VAC, 10 A\*, 50-60 Hz. **OUTPUT AC (POWER OUTLET)** 100- 40 VAC (8 A max) 50-60 Hz. **OUTPUT USB-C PD CHARGE PORT** 65W

\*North America: NEMA 5-15P (120v 3-prong)

\*India: 16A

### Space requirements

**DOOR SWING ANGLE** 180°

### Door handedness

Left-handed by default (can also be installed right-handed)

### Movability

Relocate the pod without the need for disassembly by adding casters with a movability kit. Compatible with Framery Four and Six. The kit is reusable. Multiple pods can be moved with one kit

## SHIPPING CRATE DIMENSIONS

### Crate 1

**SIZE** 222 x 89 x 149 cm / 87.4 x 35 x 58.7 in (l, w, h). **WEIGHT** 392 kg / 864 lb

### Crate 2

**SIZE** 224 x 113 x 116 cm / 88.2 x 44.5 x 46.7 in (l, w, h). **WEIGHT** 505 kg / 1113 lb

Crate 1 is stacked on top of Crate 2

## DIMENSIONS / POWER CORD SPECIFICATIONS

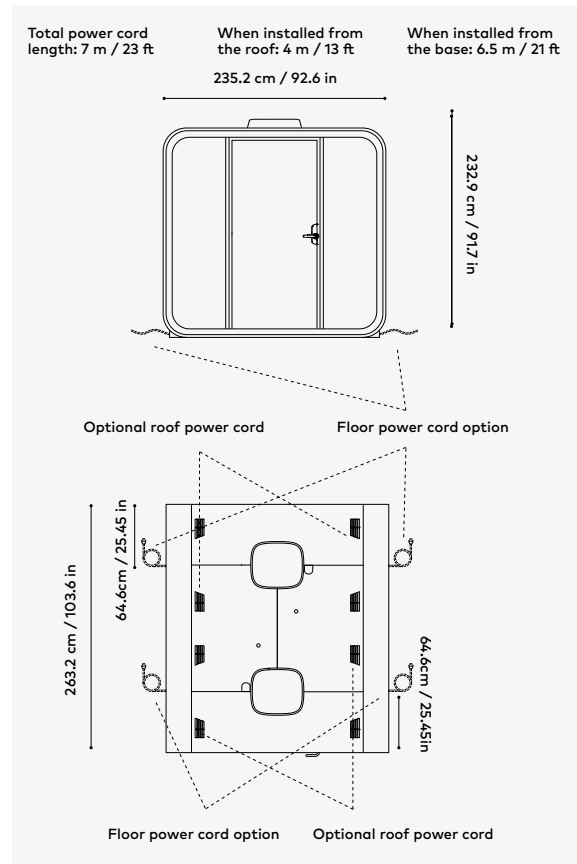

See all pod dimensions.



For the doers,  
leaders, thinkers,  
dreamers, creators,  
teams, pioneers  
and innovators.  
**For people who  
get it done.**