

Framery Gradus Huddle™

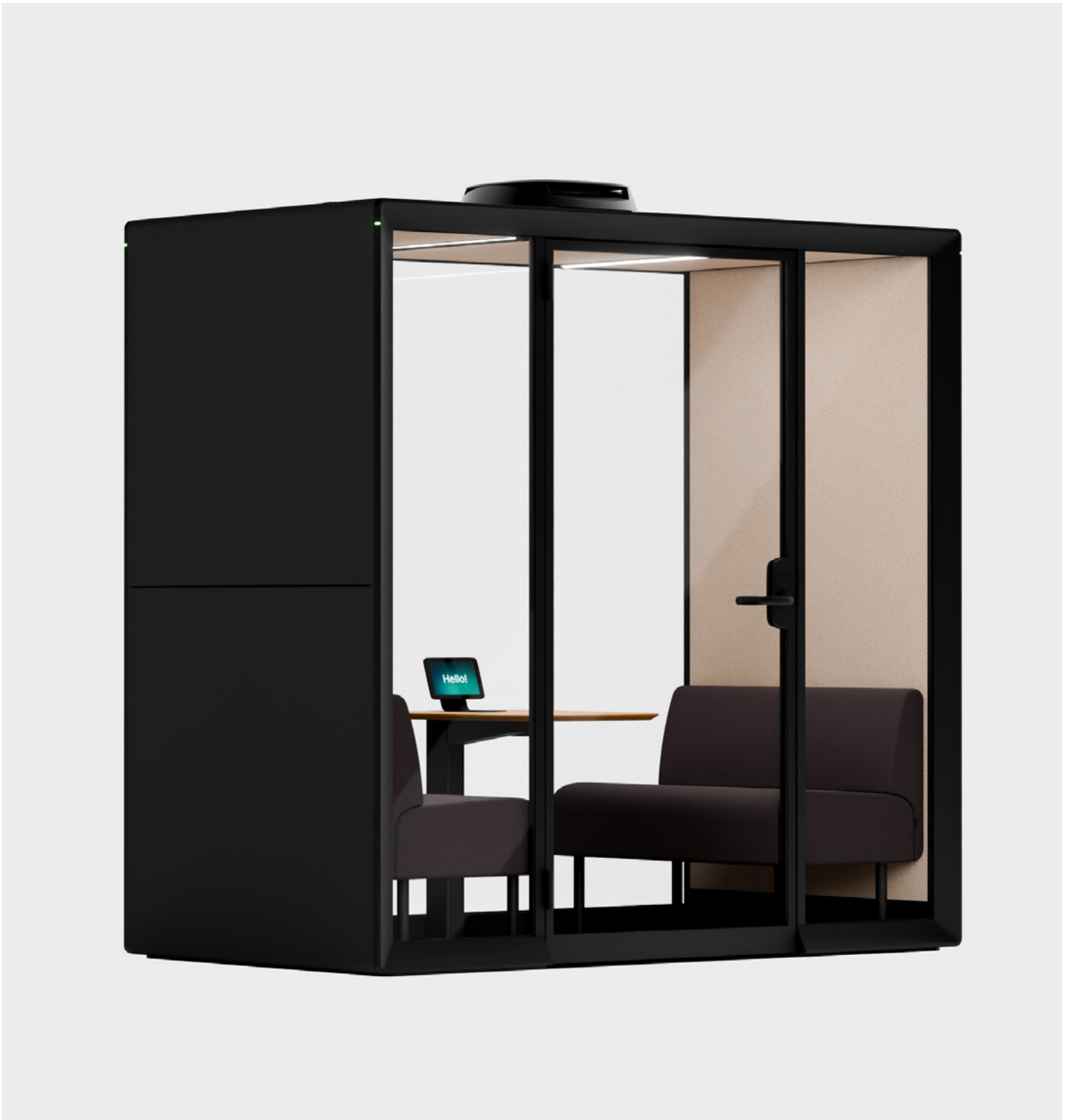

The smart and soundproof huddle room for 1-4 people

framery



The Framery Gradus Huddle is a smart and soundproof huddle room and meeting pod for collaborative sessions and private meetings for up to four people. Designed as a functional space divider and a social anchor for office neighborhoods, it provides a confidential environment for spontaneous syncs and 1-to-1s. The pod features firm, high-quality sofas and a wide-set table built to accommodate laptops and notebooks, all supported by the three pillars of a high-performance workspace: Class A soundproofing, adaptive ventilation, and versatile lighting. This room maximizes interior volume, ensuring that every hybrid meeting is comfortable, focused, and effortless.

Framery Gradus Huddle / Product highlights



Full privacy

Gradus Huddle provides a private environment for collaboration and hybrid meetings. Class A acoustics prevent sound leakage, protecting both the privacy of the meeting and the quiet of the office. For added focus, optional privacy films offer a visual shield, ensuring teams maintain their flow without interruption, even in the heart of a busy office.



Optimal environment

Stay fresh and focused with efficient airflow and powerful lighting. Simply step inside and choose your preferred lighting mode: Standard for focus work or Video mode for hybrid meetings. The pod senses the amount of people inside, the surrounding temperature and humidity and adjusts the airflow accordingly.



Made for you

Designed specifically for North American workplaces and people, Gradus Huddle offers total aesthetic flexibility. It serves as a versatile canvas for any environment, allowing you to choose whether the pod blends seamlessly into the existing architecture or stands out as a design statement. With an extensive selection of wall panels, premium materials, and color options, Gradus is built to adapt to your specific requirements and office aesthetic.



Local reliability

Assembled in the USA, our Michigan-based assembly line ensures fast lead times and a rapid response to project schedules. Gradus represents uncompromising American manufacturing quality: engineered to last and evolve within the modern professional landscape. Every pod is built for long-term reliability and is fully compliant with the strictest North American safety and building standards from day one.

Framery Gradus Huddle / Tech features

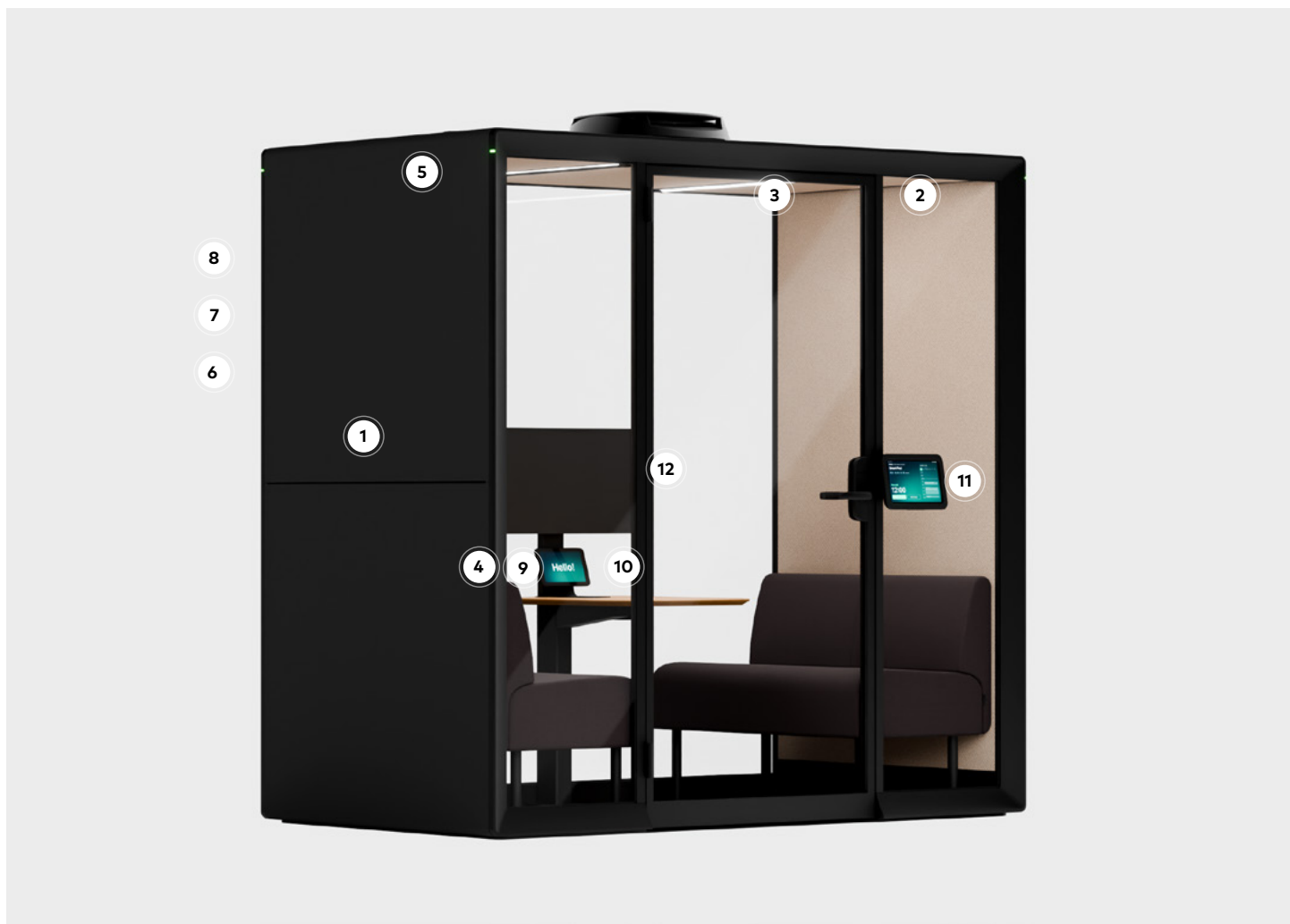

1. A-CLASS SOUNDPROOFING

Guaranteed privacy with an industry-leading Class A speech level reduction of 30dB and one of the industry's top ISO 23351-1 ratings for office phone booths.

2. ADAPTIVE AIRFLOW

The pod senses the number of people, the temperature, and the humidity of the surroundings, and adjusts the airflow accordingly. It can also be adjusted manually.

3. AUTOMATIC LIGHTING MODES

The 4000K LED light sources let you seamlessly switch between video and work modes – or make manual adjustments for personalized illumination.

4. 8-INCH TOUCHSCREEN

An intuitive, 8-inch high-resolution touchscreen makes it easy to control pod settings, adjust lighting and airflow, and extend calendar reservations effortlessly.

5. OCCUPANCY LIGHTS

The occupancy lights in the top corners outside the pod indicate the pod's status: green for vacant, yellow for a reservation starting soon, and red for occupied.

6. BUILT-IN 4G CONNECTION

Connected through 4G or Wi-Fi, enabling the smart features and future-proof technology.

7. AUTOMATIC UPDATES

Receive automatic over-the-air (OTA) feature, system, and maintenance updates – available only for connected pods.

8. USAGE DATA

Get valuable usage and people-counting data and monitor in Framery Connect how your pod is utilized to make data-driven decisions that optimize and develop your workplace.

9. BOOKABLE PODS

Make your smart pod bookable like any meeting room. The pod's touchscreen will show reservations, and you can manage them on the spot.

10. AUTOMATED WALK-IN RESERVATIONS

Step inside to instantly create a walk-in reservation that syncs with your company calendar.

11. EXTERNAL ROOM PANEL

Add Framery Room Display to the outside of your pod to show upcoming reservations and make on-the-spot bookings.

12. MONITOR ARM

Add a display with our optional monitor arm. The monitor is not included.

Framery Gradus Huddle / Design details

Its architectural clarity allows it to blend into space while offering a clear destination for teamwork. For designers, it offers the ultimate aesthetic flexibility; a quiet design that enhances the professional landscape. A rotating monitor arm allows for effortless presenting, while high-quality sofas, a spacious table, and integrated outlets creates a seamless meeting space for groups.



Add a rotating monitor arm for effortless presentation sharing. The flexible design reaches every angle to easily show work to colleagues sitting next to you.



Gradus Huddle features firm, high-quality sofas and a wide table with plenty of space for laptops and notebooks. The table's curved design ensures easy entry and a functional workspace.



Easily accessible power outlets, USB-C PD charge ports (65W), and LAN ports keep everyone's devices charged and connected throughout the session.



In addition to industry-leading soundproofing, our privacy films offer smooth visual privacy for confidential and private discussions.



Designed to blend in – or stand out. A refined material library, offering limitless opportunities to tailor pods to your project.







The occupancy lights in the top corners of the pod indicate the pod's status: green for vacant, yellow for a reservation starting soon, and red for occupied.

Framery Gradus Huddle / Colors and finishes

EXTERIORS

	White (Standard) RAL 9016 Ultramatt
	Black (Standard) RAL 9005 Ultramatt
	Gray (Standard) S 7500 - N Ultramatt
	Navy S 7020 - R90B Ultramatt
	Sand S 2010 - Y20R Ultramatt
	Powder Blue 3421-R86B Ultramatt
	Winter Moss S 7010-G10Y Ultramatt
	Blush 2728-R01B Ultramatt





INTERIORS

	Pure Gray (Standard) Tonal #60123 Gabriel
	Arctic Blue Tonal #66185 Gabriel
	Sand Tonal #61180 Gabriel
	Rouge Tonal #64210 Gabriel

CARPETS

	Light Gray (Standard) Fletco carpets
	Dark Blue Fletco carpets
	Champagne Fletco carpets
	Grape Fletco carpets

TABLE TOPS

	White (Standard) White laminate
	Black Black Laminate with anti-fingerprint surface
	Oak Veneer
	Walnut Veneer

CUSHIONS FOR GRADUS HUDDLE

	Charcoal Capture #5501 Gabriel
	Latte Capture #3301 Gabriel

SEATING FABRICS

	Graphite (Standard) Select #60051 Gabriel
	Dark Blue Select #66144 Gabriel
	Grape Select #61190 Gabriel
	Rose Select #65117 Gabriel
	Powder Blue Select #67098 Gabriel
	Beige Select #61184 Gabriel
	Green Select #68209 Gabriel
	Mustard Select #62098 Gabriel

Design your own
on our website



MATERIALS AND FINISHES



EXTERIORS of the pod include powder-coated steel panels with a matte finish. More texture and finishes can be added with wooden or fabric wall panels – choose our own designs or tailor your own fabric panels.



INTERIOR PANELS made from high-quality and recycled polyester have a vibrant and dynamic look thanks to the mix of the two-colored fabric.

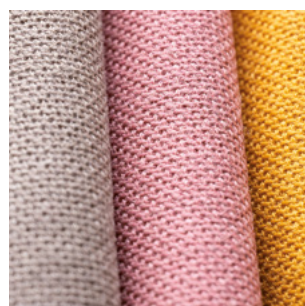

SEATING MATERIALS are a blend of superior New Zealand wool and polyamid that form a soft and rich texture. The extremely durable fabrics are both dirt and water repellent.



CARPET FLOORING is anti-static, stain resistant, and durable, giving the pod an overall soft look and finish.

Framery smart office solutions / Make any space smart with Framery

Framery smart office solutions are workplace tools that help workplace managers make data-driven office design decisions and access workplace insights through intuitive dashboards. The seamless room booking solutions deliver a premium employee experience. Pair the solutions with Framery smart pods, or turn any office space into a smart workspace.



NEW

Framery Room Sensor™

WORKPLACE MANAGEMENT Utilize private and advanced occupancy and people-counting data to create the ideal work environment for both focused solo work and collaboration. Identify underutilized and improperly used spaces to make precise layout adjustments, effectively cutting costs and maximizing real estate ROI.

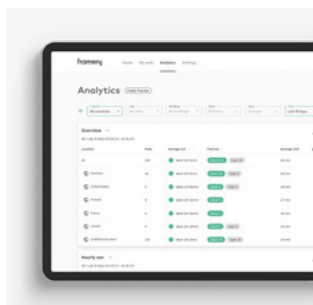

Framery Connect™

WORKPLACE MANAGEMENT
A smart platform for workplace management.

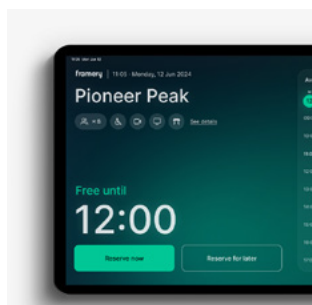

Framery Room Display™

ROOM BOOKING SOLUTIONS
See availability and book any room with ease.

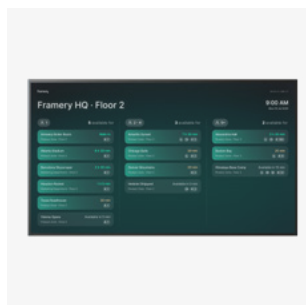

Framery Space Overview™

ROOM BOOKING SOLUTIONS
Shows real-time availability of nearby spaces.

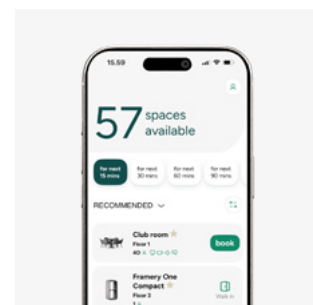

Framery App™

ROOM BOOKING SOLUTIONS
Find and book spaces in seconds.

Accessory kits

Add a complete hardware kit for your Framery Room Display and Space Overview, or use your own equipment.

Automatic updates

Instantly receive software updates through your smart pod's 4G connection to enable the future developments.

Privacy assured

No identifiable user data is collected —only workspace occupancy information is tracked.

FREE SUBSCRIPTION FOR NEW SMART POD OWNERS

Receive a complimentary 3-month Plus subscription, giving access to all our smart office solutions.

Read more



Framery Gradus pods / Compliance and environmental data sheet

Engineered for the North American workspace

Gradus pods are specialized for North American offices and buildings. They are engineered specifically to meet the local regulations and standards of the US and Canadian markets. In addition to our in-house compliance team, we work with local engineers and consultants that help manage interactions with local inspectors and building officials.

Certified safety for every user

Framery Gradus is tested and designed to exceed the most important safety and environmental benchmarks.

- **UL 962:** OSHA requires all workplace electrical equipment, including pods, to be tested and certified by a Nationally Recognized Testing Laboratory. UL 962 aligns with the requirements set out in the National Electric Code or NFPA 70. Certification against UL 962 ensures that the pod is safe to use. It has been thoroughly evaluated for all safety risks related to electricity, fire, structural integrity and furnishings.
- **ICC-ES ESR4445:** This evaluation service report certifies that the pod meets the acceptance criteria 519 for acoustic pods. All product testing and 3rd party reports are verified and on-site audits confirm the manufacturing and quality processes meet the stringent requirements of ICC-ES.
- **UL GREENGUARD Gold:** This test measures the emissions (Volatile Organic Compounds) of the pod in a sealed environmental chamber capable of detecting over 10,000 different chemicals. The test can take up to 2 weeks, and the sensitive equipment can detect levels as low as 1 microgram per square meter.

Designed for local Building Codes

Framery Gradus pods are designed with the International Codes in mind. This makes it straightforward to add pods to any building or office in North America.

- **International Building Code (IBC):** This code is used for the design and installation of innovative materials and structures. It ensures the pod meets public health and safety goals regarding its physical construction and placement.
- **International Fire Code (IFC):** This focuses on fire and life safety. It regulates how pods interact with fire suppression systems like sprinklers and ensures they do not obstruct emergency exits.
- **International Mechanical Code (IMC):** This governs mechanical systems and ventilation. For our pods, this ensures the ventilation systems provide a constant supply of fresh air and meet the standards for permanently installed indoor equipment.

Certified Autism Resource (CAR)

Framery holds the Certified Autism Resource (CAR) designation, earned after an IBCCES expert board certified its product aligns with competency areas to meet the needs of individuals with autism.



Find the sustainability report and the smart pods' EPDs by scanning the QR code or go to framery.com

Advanced life safety solutions

You can rest assured that all of the compliance requirements, test reports and certifications have been completed. Our pods are fully compatible with fire sprinklers, and notification devices. Pods have also been seismic tested and pass requirements from ASCE 7-16. Seismic restraints can be PE stamped for your specific location and building design. All electronics are located in the roof structure for easy access regardless of how the pods are placed or if they require sprinklers.

Circular design principles

Framery Gradus is designed to mitigate the environmental impact of office furniture—an industry where the EPA estimates approximately 80% of products eventually enter landfills. These pods are engineered as long-term architectural assets rather than short-cycle furniture.

- **Modular construction:** Every component is fully modular and replaceable. This design facilitates ongoing repair and refurbishment, extending the functional lifespan of the unit.
- **Material selection:** The use of high-grade, durable materials ensures structural integrity under heavy-use conditions.

UN Global Compact & Science Based Targets initiative

Framery participates in the UN Global Compact as well as the Science Based Targets initiative and have set greenhouse gas emission reduction targets aligned with the goal of limiting global warming to 1.5°C compared to pre-industrial levels.

Reporting & Transparency

Framery provides third-party verified Environmental Product Declarations (EPDs) for the entire Gradus line. These documents are publicly available to all customers. This allows organizations to rely on accurate and verified data for their own value chain reporting and carbon budgets. North American designers and facility managers require radical transparency. We have made sure Gradus EPDs are ready upon launch because sustainability claims must be backed by data.

Ecovadis

Framery has been awarded with a Gold Medal sustainability rating from Ecovadis sustainability – placing us among the top 5% percent of companies assessed in the past year.



Certificates and studies available:

Certificates and studies available:

- Life Cycle Assessment (LCA)
- Environmental Product Declarations (EPDs)
- Health Product Declarations (HPD)
- Declare labels
- UL GREENGUARD Gold
- Contribution to green building certifications such as LEED certifications, BREEAM, SKA and WELL

Framery Gradus Huddle™

Technical specifications

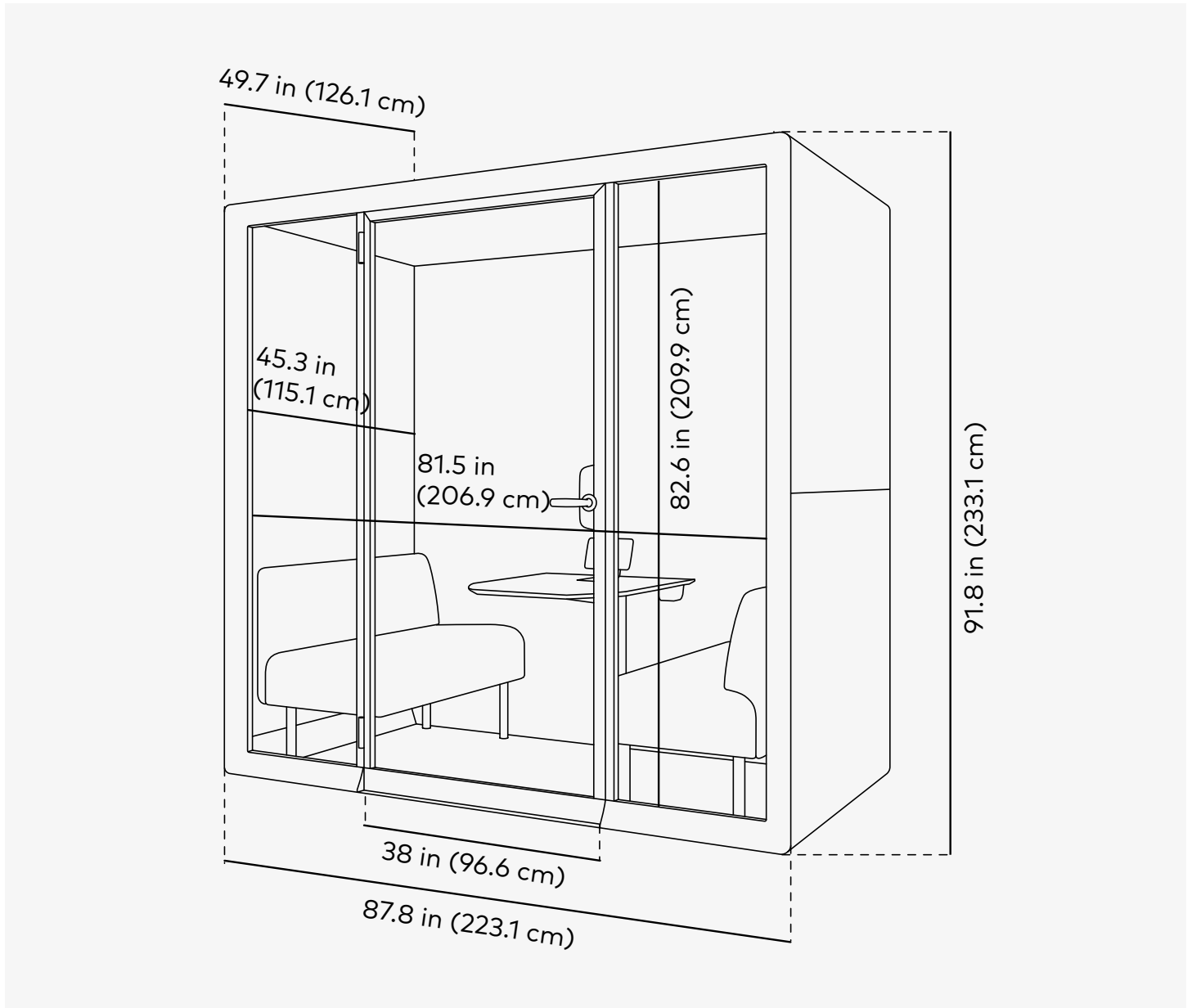

Performance

Speech level reduction: 30dB

Max airflow: 203 CFM

Default energy consumption: 38 W

Sustainable design

Built to last for decades

Light-weight product structures

Refurbishable & movable

Connectivity

Built-in 4G connection

Automatic software updates

Smart office solutions

Framery Gradus Huddle / Technical specifications

OVERVIEW

Soundproofing	CLASS A 30 DS,A (dB) reduction Speech level reduction DS,A (dB) is measured using ISO 23351-1. Pod can be placed next to workspaces without compromising privacy.
Ventilation	MAXIMUM AIRFLOW 203 CFM, 346 m ³ /h (96 l/s). TYPICAL AIRFLOW 159 CFM, 270 m ³ /h (75 l/s) when in use. After use, the pod refreshes itself with a higher ventilation speed. STANDBY MODE 136 CFM, 230 m ³ /h (64 l/s).
Lighting	DOUBLE CEILING LIGHT Color temperature 4000 K, illuminance up to 500 lux on the table top. VIDEO LIGHT Color temperature 4000 K, illuminance up to 585 lux on the user's face. PRE-SET LIGHTING MODES Standard mode & Video call mode. Lighting can also be adjusted also manually.
Presence detection	SENSOR TECHNOLOGY mmWave radar.
Dimensions	EXTERIOR with air filter housing 91.8 x 87.8 x 49.7 in (233.1 x 223.1 x 126.1 cm) (h,w,d). DOORWAY 82.6 x 38 in / 209.9 x 96.6 cm (h, w). WEIGHT 1102.3 lb / 500 kg. THRESHOLD 0.5 in / 1.25 cm. DOOR SWING ANGLE 180°.
Touchscreen location	On the table.
Connectivity	Framery smart pods gather anonymous occupancy data, measuring when and how often spaces are used. Users in the space cannot be identified and no personally identifiable data is collected. The anonymous data is transferred via built-in 4G connectivity, or through a Wi-Fi connection and compiled and shown in the Framery Connect platform. WLAN Wi-Fi 802.11 a/b/g/n/ac 2.4&5 GHz

DIMENSIONS / MAIN VIEW

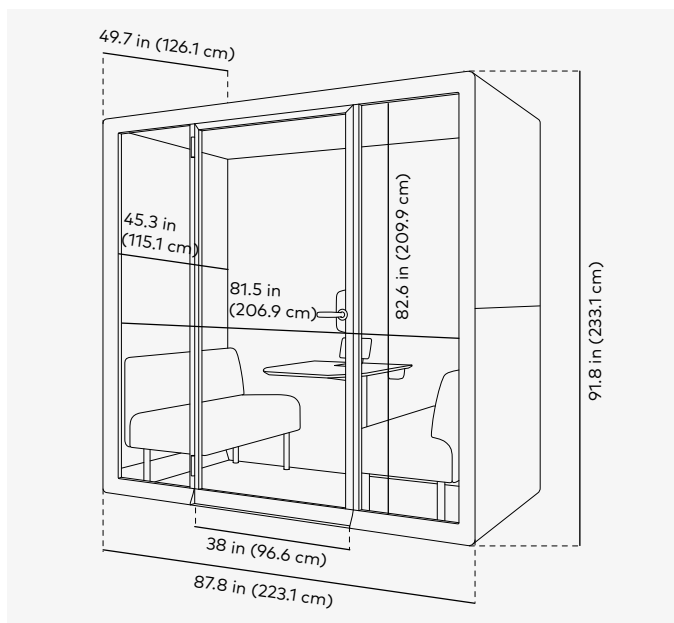

DIMENSIONS / THRESHOLD

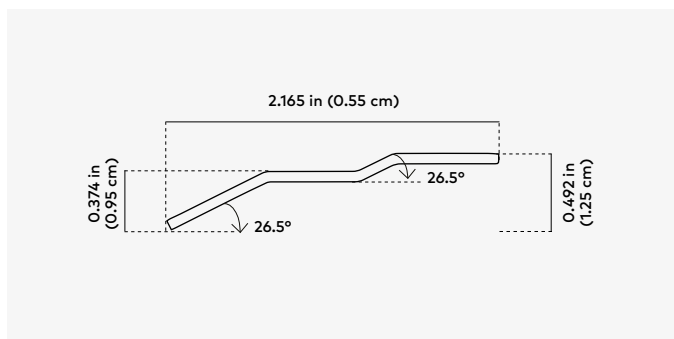

UL GREENGUARD GOLD



framery

Framery Gradus Huddle / Technical specifications

MATERIALS

Exterior

EXTERIOR PANELS Powder coated matt steel panels.
FRAMES Structure matt black aluminum.
DOOR FRAME Structure matt black aluminum.
GLASS Sound control laminated glass (0.16 + 0.16 in / 4 + 4 mm).
CHASSIS Light steel and PET sound-absorbing structure.
HANDLE Custom-designed black metal.

Interior

INTERIOR PANELS PET sheets laminated with recycled polyester fabric.
UPHOLSTERY FABRIC Gabriel Tonal.
CARPET Antistatic and stain resistant low loop pile carpet.
TABLE Table top is birch plywood laminated with white, black anti-fingerprint, oak or walnut.
TABLE LEG Structure black metal.

Seating materials

UPHOLSTERY FABRIC Gabriel Select.
FABRIC COMPOSITION 85 % New Zealand wool / 15 % Polyamide.

Furniture dimensions

TABLE 34.6 x 27.2 in / 88 cm x 69 cm (w, d).
TABLE HEIGHT Fixed height from floor 28 in / 71 cm.
MAX LOAD FOR THE TABLE 131 lb / 60 kg.
SOFA SIZE 43.3 x 23 in / 110 x 58.5 cm (w, d).
SEAT HEIGHT Fixed seating height from floor 18.5 in / 47 cm (backrest height 30.9 in / 78,5 cm).
MAX LOAD FOR SOFA 600 lb / 270 kg.

Optional accessories

ROTATING MONITOR ARM Max monitor size 24"-27". Max weight 15 kg / 33 lbs with a flat 75 x 75 or 100 x 100 center-positioned VESA mounting surface. Monitor not included.
WALL PANELS Make your Gradus pods blend in, or stand out, with our interchangeable wall panels. Choose between wooden, fabric, or custom fabric.
PRIVACY FILM Add Framery's privacy film to the glass surfaces of the pod for visual privacy. Requires professional installers.
FRAMERY ROOM DISPLAY KIT Add Framery Room Display outside your smart pod with our full kit: exterior tablet mount, tablet holder and tablet. Same as Smart Pod Kit in Smart Office portfolio.

DIMENSIONS / FURNITURE / TOP VIEW

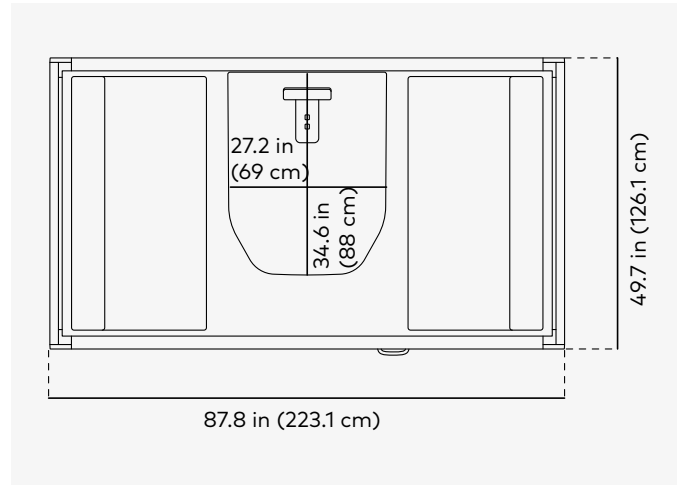

DIMENSIONS / FURNITURE / FRONT VIEW

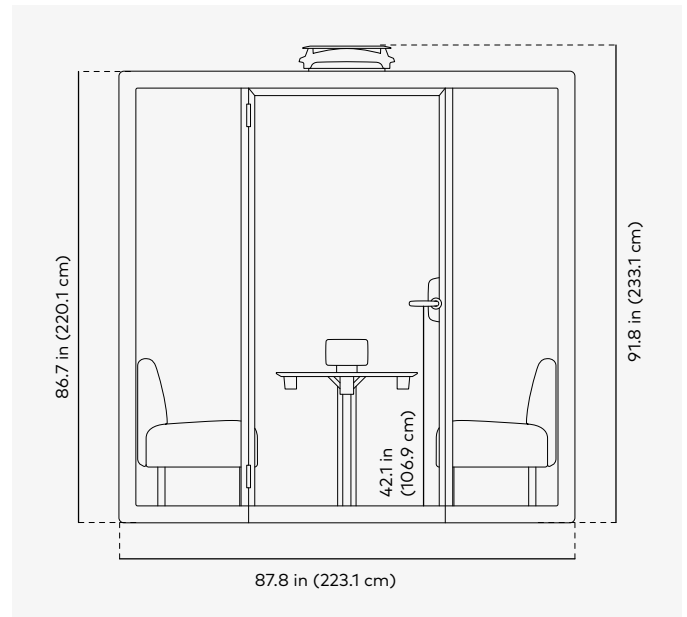

Framery Gradus Huddle / Technical specifications

POWER AND OTHER

Power

POWER CONSUMPTION Default settings 38 W. Highest settings 96 W. Standby mode 13 W.
INPUT 120 VAC, 10 A*, 60 Hz.
*(NEMA 5-15P 3-prong plug)
OUTPUT AC (POWER OUTLET) 120 VAC, 6A, 60 Hz.
OUTPUT USB-C PD CHARGE PORT 65W. FRAMERY GRADUS HUDDLE ESSENTIALS
OUTLETS 4 x power outlets (2 x power outlets on each side of the pod), 2 x USB-C PD charge ports (65 W). Optional: 2 x under-table power outlets (included with the monitor arm).
 Optional in-table outlets (max. 2): 1-2 x LAN ports (with cables).
FRAMERY GRADUS HUDDLE BASE
OUTLETS 4 x power outlets (2 x power outlets on each side of the pod). Optional: 2 x under-table power outlets. Optional outlets (max 4): 1-2 x USB-C PD charge ports (65 W), 1-2 x LAN ports (with cables).

Door handedness Left-handed by default (can also be installed right-handed)

Movability Relocate the pod without the need for disassembly by adding casters with a movability kit. Compatible with Framery Gradus Work and Huddle. The kit is reusable. Multiple pods can be moved with one kit.

SAFETY

Fire safety No fire hazardous materials are used in Framery pods. The fire safety of all surface materials, upholstery and acoustics materials of our products are tested and classified by either national or international standards. Framery provides additional safety measurements to adhere to local regulatory requirements.

Seismic safety Framery pods comply with seismic testing in accordance with ASCE 7-16 and are designed for easy floor anchoring.

SHIPPING CRATE

Pallet **SIZE** 31.5 x 47.2 x 29.5 in / 80 x 120 x 75 cm.
WEIGHT 110 lb / 50 kg.

Crate **SIZE** 89.8 x 33.1 x 52 in / 228 x 84 x 132 cm.
WEIGHT 1212.5 lb / 550 kg.

Pallet is stacked on top of Crate.

DIMENSIONS / POWER CORD SPECIFICATIONS

Total power cord length: 23 ft (7 m)
 When installed from the roof: 12.3 ft (3.75 m)
 When installed from the base: 19.4 ft (5.9 m)

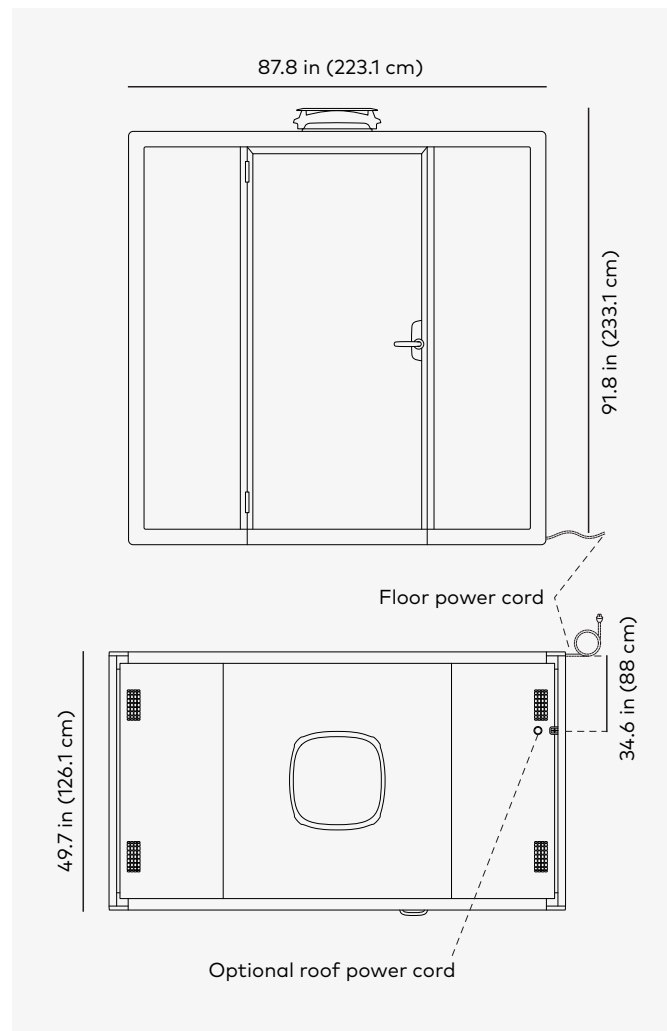

See all pod dimensions.



For the doers,
leaders, thinkers,
dreamers, creators,
teams, pioneers
and innovators.

**For people who
get it done.**