

# Framery Gradus Work™



The smart and soundproof work pod for one person

**framery**



The Framery Gradus Work is a smart and soundproof workstation pod for focus and hybrid work. It is the best-equipped private workstation in the professional landscape, featuring a full-sized, height-adjustable desk and the three pillars of a high-performance workspace: Class A soundproofing, adaptive ventilation, and versatile lighting. By maximizing interior volume, Gradus Work provides a spacious, permanent-feeling environment for high-output productivity and uninterrupted flow.

## Framery Gradus Work / Product highlights



### Full privacy

Gradus Work's market-leading acoustic privacy eliminates surrounding noise, allowing you to focus on the task at hand. Visual privacy ensures you can stay in the flow without interruptions, even in the heart of a busy office.



### Optimal environment

Stay fresh and focused with efficient airflow and powerful lighting. Simply step inside and choose your preferred lighting mode: Standard for focus work or Video mode for hybrid meetings. The pod senses the surrounding temperature and humidity and adjusts the airflow accordingly.



### Made for you

Designed specifically for North American workplaces and people, Gradus Work offers total aesthetic flexibility. It serves as a versatile canvas for any environment, allowing you to choose whether the pod blends seamlessly into the existing architecture or stands out as a design statement. With an extensive selection of wall panels, premium materials, and color options, Gradus is built to adapt to your specific requirements and office aesthetic.



### Local reliability

Assembled in the USA, our Michigan-based assembly line ensures fast lead times and a rapid response to project schedules. Gradus represents uncompromising American manufacturing quality: engineered to last and evolve within the modern professional landscape. Every pod is built for long-term reliability and is fully compliant with the strictest North American safety and building standards from day one.

## Framery Gradus Work / Tech features



### 1. A-CLASS SOUNDPROOFING

Guaranteed privacy with an industry-leading Class A speech level reduction of 30dB and one of the industry's top ISO 23351-1 ratings for office phone booths.

### 2. ADAPTIVE AIRFLOW

The pod senses the surrounding temperature and humidity and adjusts the airflow accordingly. It can also be adjusted manually.

### 3. AUTOMATIC LIGHTING MODES

The 4000K LED light sources let you seamlessly switch between video and work modes – or make manual adjustments for personalized illumination.

### 4. 8-INCH TOUCHSCREEN

An intuitive, 8-inch high-resolution touchscreen makes it easy to control pod settings, adjust lighting and airflow, and extend calendar reservations effortlessly.

### 5. OCCUPANCY LIGHTS

The occupancy lights in the top corners outside the pod indicate the pod's status: green for vacant, yellow for a reservation starting soon, and red for occupied.

### 6. BUILT-IN 4G CONNECTION

Connected through 4G or Wi-Fi, enabling the smart features and future-proof technology.

### 7. AUTOMATIC UPDATES

Receive automatic over-the-air (OTA) feature, system, and maintenance updates – available only for connected pods.

### 8. USAGE DATA

Get valuable usage data and monitor in Framery Connect how your pod is utilized to make data-driven decisions that optimize and develop your workplace.

### 9. BOOKABLE PODS

Make your smart pod bookable like any meeting room. The pod's touchscreen will show reservations, and you can manage them on the spot.

### 10. AUTOMATED WALK-IN RESERVATIONS

Step inside to instantly create a walk-in reservation that syncs with your company calendar.

### 11. EXTERNAL ROOM PANEL

Add Framery Room Display to the outside of your pod to show upcoming reservations and make on-the-spot bookings.

### 12. MONITOR STAND

Choose between one or two displays. The monitors are not included.

---

## Framery Gradus Work / Design details

Gradus Work is designed to blend into the office while standing out in performance. With its versatile exterior design and minimalist silhouette, it offers designers total aesthetic flexibility. An electric desk provides versatility for every user, transitioning seamlessly between sitting and standing for optimal ergonomics at any height. Charge your devices and instantly switch to focus mode in this full-sized workstation.



Enjoy a full-sized workstation tailored to your needs. While a sturdy fixed desk is standard, you can upgrade to an electric version for full height-adjustability and to seamlessly transition between sitting and standing for ideal ergonomics.



Choose between multiple screen layout options to optimize your workspace's usability: a wide screen up to 37" or two screens next to each other (up to 24" each) in either landscape or portrait orientation.



Stay fully charged throughout your work session with power outlets, USB-C PD charge ports (65W) and LAN ports.

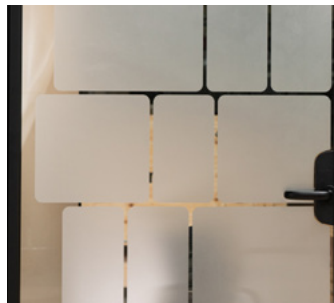

In addition to industry-leading soundproofing, our privacy films offer smooth visual privacy for uninterrupted work.



Designed to blend in – or stand out. A refined material library, offering limitless opportunities to tailor pods to your project.







A wide doorway and low threshold enable an easy entry for wheelchair users in accordance with ADA guidelines.

# Framery Gradus Work / Colors and finishes

## EXTERIORS

-  White (Standard)  
RAL 9016 Ultramatt
-  Black (Standard)  
RAL 9005 Ultramatt
-  Gray (Standard)  
S 7500 - N Ultramatt
-  Navy  
S 7020 - R90B Ultramatt
-  Sand  
S 2010 - Y20R Ultramatt
-  Powder Blue  
3421-R86B Ultramatt
-  Winter Moss  
S 7010-G10Y Ultramatt
-  Blush  
272B-R01B Ultramatt





## INTERIORS

-  Pure Gray (Standard)  
Tonal #60123 Gabriel
-  Arctic Blue  
Tonal #66185 Gabriel
-  Sand  
Tonal #61180 Gabriel
-  Rouge  
Tonal #64210 Gabriel

## CARPETS

-  Light Gray (Standard)  
Fletco carpets
-  Dark Blue  
Fletco carpets
-  Champagne  
Fletco carpets
-  Grape  
Fletco carpets

## TABLE TOPS

-  White (Standard)  
White laminate
-  Black  
Black Laminate with  
anti-fingerprint surface
-  Oak Veneer
-  Walnut Veneer

Design your own  
on our website

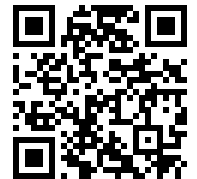

## MATERIALS AND FINISHES

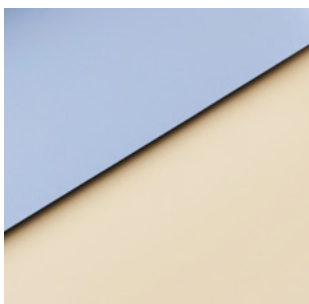

EXTERIORS of the pod include powder-coated steel panels with a matte finish. More texture and finishes can be added with wooden or fabric wall panels – choose our own designs or tailor your own fabric panels.



INTERIOR PANELS made from high-quality and recycled polyester have a vibrant and dynamic look thanks to the mix of the two-colored fabric.



CARPET FLOORING is anti-static, stain resistant, and durable, giving the pod an overall soft look and finish.

---

# Framery smart office solutions / Make any space smart with Framery

Framery smart office solutions are workplace tools that help workplace managers make data-driven office design decisions and access workplace insights through intuitive dashboards. The seamless room booking solutions deliver a premium employee experience. Pair the solutions with Framery smart pods, or turn any office space into a smart workspace.



NEW

## Framery Room Sensor™

**WORKPLACE MANAGEMENT** Utilize private and advanced occupancy and people-counting data to create the ideal work environment for both focused solo work and collaboration. Identify underutilized and improperly used spaces to make precise layout adjustments, effectively cutting costs and maximizing real estate ROI.

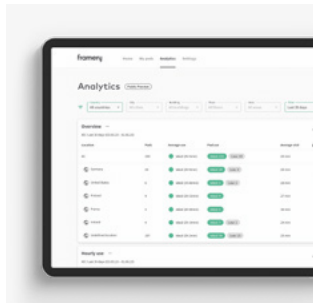

## Framery Connect™

**WORKPLACE MANAGEMENT**  
A smart platform for workplace management.

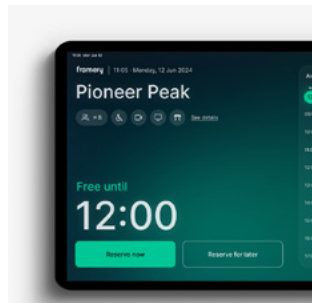

## Framery Room Display™

**ROOM BOOKING SOLUTIONS**  
See availability and book any room with ease.



## Framery Space Overview™

**ROOM BOOKING SOLUTIONS**  
Shows real-time availability of nearby spaces.

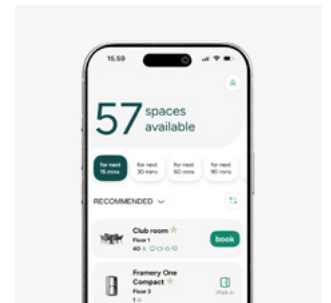

## Framery App™

**ROOM BOOKING SOLUTIONS**  
Find and book spaces in seconds.

### Accessory kits

Add a complete hardware kit for your Framery Room Display and Space Overview, or use your own equipment.

### Automatic updates

Instantly receive software updates through your smart pod's 4G connection to enable the future developments.

### Privacy assured

No identifiable user data is collected —only workspace occupancy information is tracked.

---

## FREE SUBSCRIPTION FOR NEW SMART POD OWNERS

Receive a complimentary 3-month Plus subscription, giving access to all our smart office solutions.

Read more



# Framery Gradus pods / Compliance and environmental data sheet

## Engineered for the North American workspace

Gradus pods are specialized for North American offices and buildings. They are engineered specifically to meet the local regulations and standards of the US and Canadian markets. In addition to our in-house compliance team, we work with local engineers and consultants that help manage interactions with local inspectors and building officials.

## Certified safety for every user

Framery Gradus is tested and designed to exceed the most important safety and environmental benchmarks.

- **UL 962:** OSHA requires all workplace electrical equipment, including pods, to be tested and certified by a Nationally Recognized Testing Laboratory. UL 962 aligns with the requirements set out in the National Electric Code or NFPA 70. Certification against UL 962 ensures that the pod is safe to use. It has been thoroughly evaluated for all safety risks related to electricity, fire, structural integrity and furnishings.
- **ICC-ES ESR4445:** This evaluation service report certifies that the pod meets the acceptance criteria 519 for acoustic pods. All product testing and 3rd party reports are verified and on-site audits confirm the manufacturing and quality processes meet the stringent requirements of ICC-ES.
- **UL GREENGUARD Gold:** This test measures the emissions (Volatile Organic Compounds) of the pod in a sealed environmental chamber capable of detecting over 10,000 different chemicals. The test can take up to 2 weeks, and the sensitive equipment can detect levels as low as 1 microgram per square meter.

## Designed for local Building Codes

Framery Gradus pods are designed with the International Codes in mind. This makes it straightforward to add pods to any building or office in North America.

- **International Building Code (IBC):** This code is used for the design and installation of innovative materials and structures. It ensures the pod meets public health and safety goals regarding its physical construction and placement.
- **International Fire Code (IFC):** This focuses on fire and life safety. It regulates how pods interact with fire suppression systems like sprinklers and ensures they do not obstruct emergency exits.
- **International Mechanical Code (IMC):** This governs mechanical systems and ventilation. For our pods, this ensures the ventilation systems provide a constant supply of fresh air and meet the standards for permanently installed indoor equipment.

## Certified Autism Resource (CAR)

Framery holds the Certified Autism Resource (CAR) designation, earned after an IBCCES expert board certified its product aligns with competency areas to meet the needs of individuals with autism.



Find the sustainability report and the smart pods' EPDs by scanning the QR code or go to [framery.com](https://framery.com)

## Advanced life safety solutions

You can rest assured that all of the compliance requirements, test reports and certifications have been completed. Our pods are fully compatible with fire sprinklers, and notification devices. Pods have also been seismic tested and pass requirements from ASCE 7-16. Seismic restraints can be PE stamped for your specific location and building design. All electronics are located in the roof structure for easy access regardless of how the pods are placed or if they require sprinklers.

## Circular design principles

Framery Gradus is designed to mitigate the environmental impact of office furniture—an industry where the EPA estimates approximately 80% of products eventually enter landfills. These pods are engineered as long-term architectural assets rather than short-cycle furniture.

- **Modular construction:** Every component is fully modular and replaceable. This design facilitates ongoing repair and refurbishment, extending the functional lifespan of the unit.
- **Material selection:** The use of high-grade, durable materials ensures structural integrity under heavy-use conditions.

## UN Global Compact & Science Based Targets initiative

Framery participates in the UN Global Compact as well as the Science Based Targets initiative and have set greenhouse gas emission reduction targets aligned with the goal of limiting global warming to 1.5°C compared to pre-industrial levels.

## Reporting & Transparency

Framery provides third-party verified Environmental Product Declarations (EPDs) for the entire Gradus line. These documents are publicly available to all customers. This allows organizations to rely on accurate and verified data for their own value chain reporting and carbon budgets. North American designers and facility managers require radical transparency. We have made sure Gradus EPDs are ready upon launch because sustainability claims must be backed by data.

## Ecovadis

Framery has been awarded with a Gold Medal sustainability rating from Ecovadis sustainability – placing us among the top 5% percent of companies assessed in the past year.



## Certificates and studies available:

Certificates and studies available:

- Life Cycle Assessment (LCA)
- Environmental Product Declarations (EPDs)
- Health Product Declarations (HPD)
- Declare labels
- UL GREENGUARD Gold
- Contribution to green building certifications such as LEED certifications, BREEAM, SKA and WELL

# Framery Gradus Work™

## Technical specifications

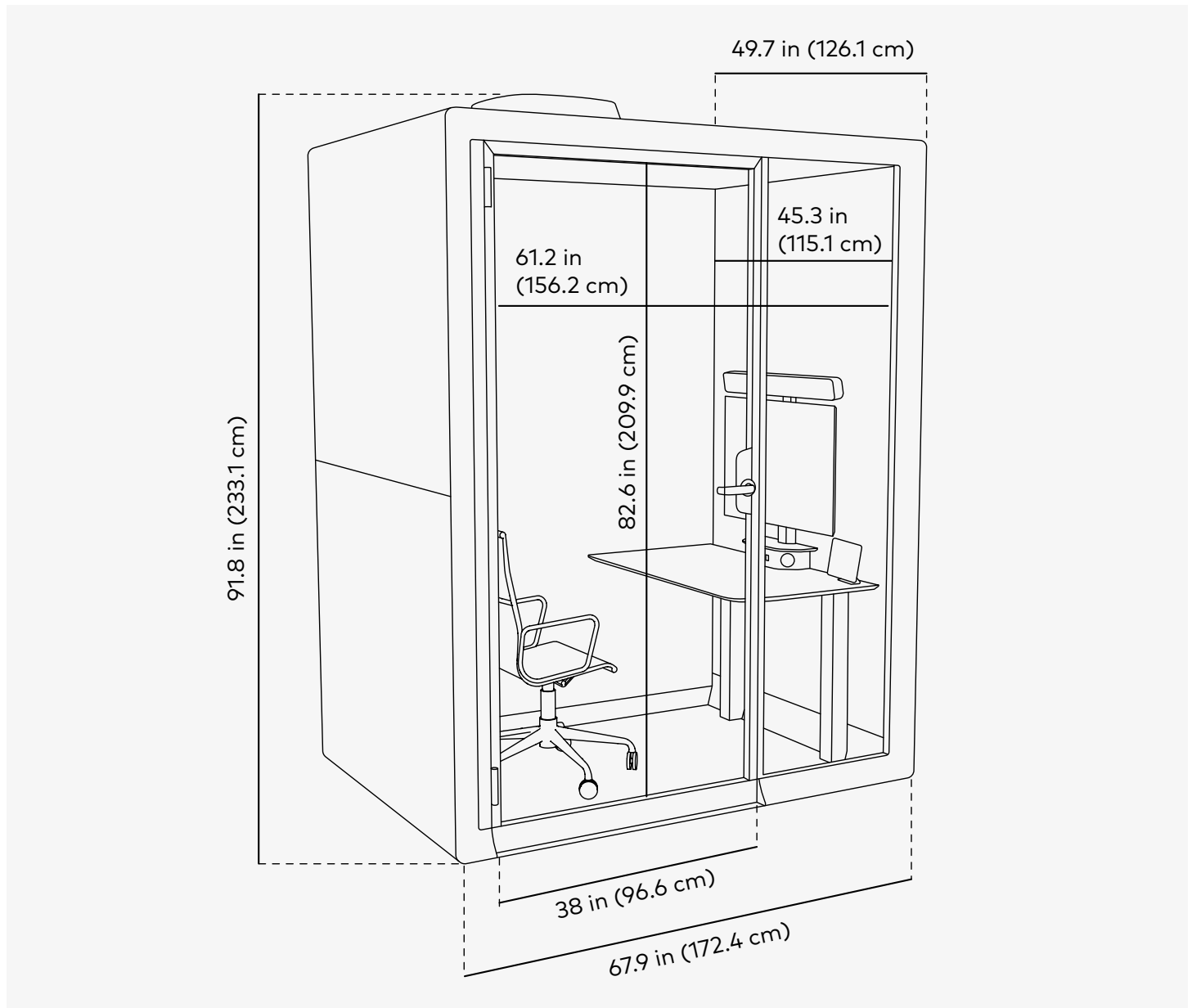

### Performance

Speech level reduction: 30dB

Max airflow: 112 CFM

Default energy consumption: 29 W

### Sustainable design

Built to last for decades

Light-weight product structures

Refurbishable & movable

### Connectivity

Built-in 4G connection

Automatic software updates

Smart office solutions

# Framery Gradus Work / Technical specifications

## OVERVIEW

Soundproofing	<b>CLASS A 30 DS,A (dB) reduction</b> Speech level reduction DS,A (dB) is measured using ISO 23351-1. Pod can be placed next to workspaces without compromising privacy.
Ventilation	<b>MAXIMUM AIRFLOW 112 CFM, 191 m3/h (53 l/s).</b> <b>TYPICAL AIRFLOW 87 CFM, 148 m3/h (41 l/s)</b> when in use. After use, the pod refreshes itself with a higher ventilation speed. <b>STANDBY MODE 71 CFM, 121 m3/h (33 l/s).</b>
Lighting	<b>DOUBLE CEILING LIGHT</b> Color temperature 4000 K, illuminance up to 300 lux on the table top. <b>VIDEO LIGHT</b> Color temperature 4000 K, illuminance up to 500 lux on the user's face. <b>PRE-SET LIGHTING MODES</b> Standard mode & Video call mode. Lighting can also be adjusted also manually.
Presence detection	<b>SENSOR TECHNOLOGY</b> mmWave radar.
Dimensions	<b>EXTERIOR</b> with air filter housing 91.8 x 67.9 x 49.7 in (233.1 x 172.4 x 126.1 cm) (h,w,d). <b>DOORWAY</b> 82.6 x 38 in / 209.7 x 96.6 cm (h,w). <b>WEIGHT</b> 881.8 lb / 400 kg. <b>THRESHOLD</b> 0.5 in / 1.25 cm. <b>DOOR SWING ANGLE</b> 180°.
Touchscreen location	On the table.
Connectivity	Framery smart pods gather anonymous occupancy data, measuring when and how often spaces are used. Users in the space cannot be identified and no personally identifiable data is collected. The anonymous data is transferred via built-in 4G connectivity, or through a Wi-Fi connection and compiled and shown in the Framery Connect platform. <b>WLAN</b> Wi-Fi 802.11 a/b/g/n/ac 2.4&5 GHz

## DIMENSIONS / MAIN VIEW

Chair not included, shown for scale only.

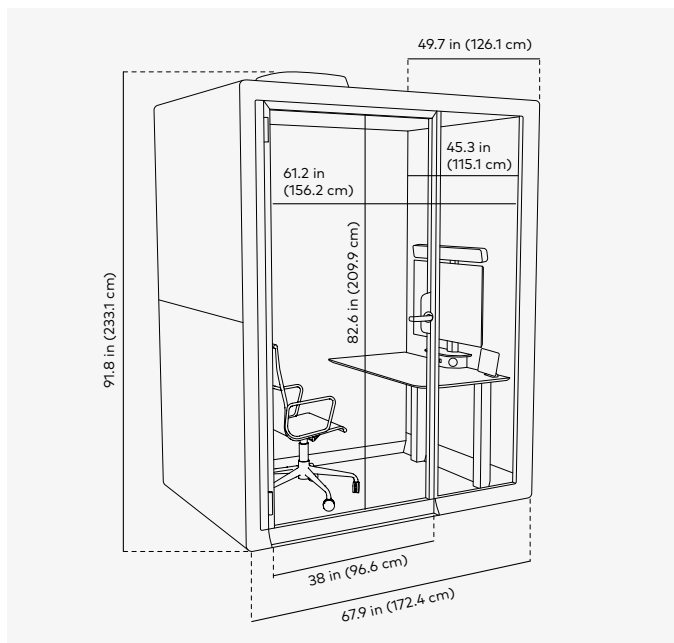

## DIMENSIONS / THRESHOLD

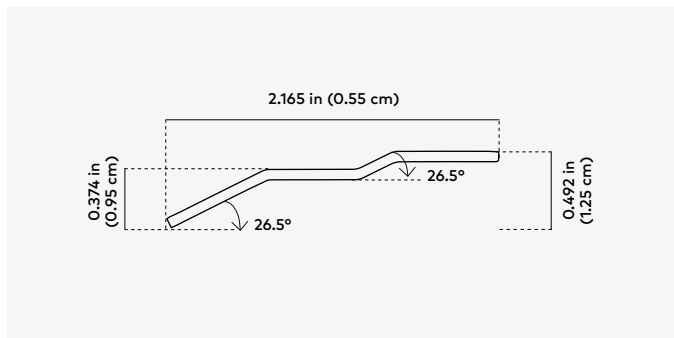

UL GREENGUARD GOLD



**framery**

# Framery Gradus Work / Technical specifications

## MATERIALS

**Exterior**

**EXTERIOR PANELS** Powder coated matt steel panels.

**FRAMES** Structure matt black aluminum.

**DOOR FRAME** Structure matt black aluminum.

**GLASS** Sound control laminated glass (0.16 + 0.16 in / 4 + 4 mm).

**CHASSIS** Light steel and PET sound-absorbing structure.

**HANDLE** Custom-designed black metal.

**Interior**

**INTERIOR PANELS** PET sheets laminated with recycled polyester fabric.

**UPHOLSTERY FABRIC** Gabriel Tonal.

**CARPET** Antistatic and stain resistant low loop pile carpet.

**TABLE** Table top is birch plywood laminated with white, black anti-fingerprint, oak or walnut.

**TABLE LEG** Smooth black adjustable table leg or structure black metal fixed table leg.

**Furniture dimensions**

**TABLE** 42.9 x 22.8 in / 109 x 58 cm (w, d).

**TABLE HEIGHT** Fixed desk: 27.6 in / 70 cm  
Height-adjustable desk: 26.8-46.5 in / 68-118 cm.

**MAX LOAD FOR THE TABLE** 132.3 lb / 60 kg.

**Optional accessories**

**DUAL-MONITOR STAND** Includes single monitor support (up to 40") by default. Optional dual-monitor upgrade available (supports two 24" screens in landscape or portrait orientation).

**WALL PANELS** Make your Gradus pods blend in, or stand out, with our interchangeable wall panels. Choose between wooden, fabric, or custom fabric.

**PRIVACY FILM** Add Framery's privacy film to the glass surfaces of the pod for visual privacy. Requires professional installers.

**FRAMERY ROOM DISPLAY KIT** Add Framery Room Display outside your smart pod with our full kit: exterior tablet mount, tablet holder and tablet. Same as Smart Pod Kit in Smart Office portfolio.

## DIMENSIONS / TABLE / TOP VIEW

Chair not included, shown for scale only.

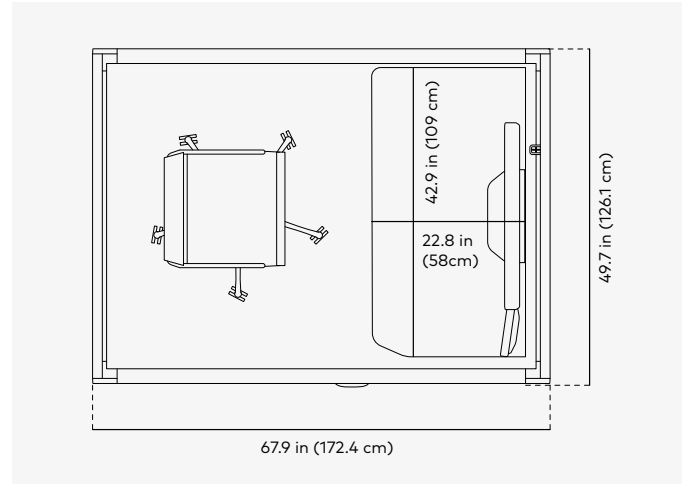

## DIMENSIONS / TABLE / FRONT VIEW

Chair not included, shown for scale only.

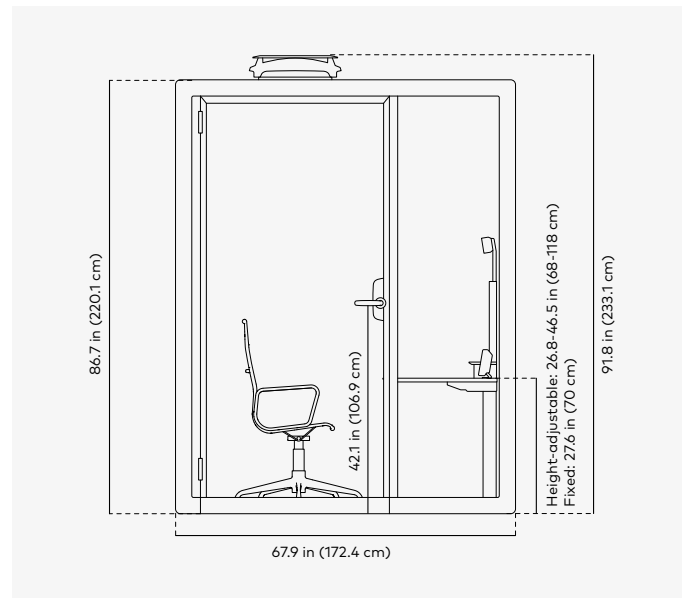

# Framery Gradus Work / Technical specifications

## POWER AND OTHER

**Power** **POWER CONSUMPTION** Default settings 29 W. Highest settings 64 W. Standby mode 13 W. **INPUT** 120 VAC, 10 A\*, 60 Hz.  
\*(NEMA 5-15P 3-prong plug)  
**OUTPUT AC (POWER OUTLET)** 120 VAC, 6A, 60 Hz.  
**OUTPUT USB-C PD CHARGE PORT** 65W.  
**OUTLETS** 2 x on-table power outlets, 2 x under-table power outlets. Optional: 2 x USB-C PD charge ports (65 W), 1-2 x LAN port (with cable).

**Door handedness** Left-handed by default (cannot be changed).

**Movability** Relocate the pod without the need for disassembly by adding casters with a movability kit. Compatible with Framery Gradus Work and Huddle. The kit is reusable. Multiple pods can be moved with one kit.

## SAFETY

**Fire safety** No fire hazardous materials are used in Framery pods. The fire safety of all surface materials, upholstery and acoustics materials of our products are tested and classified by either national or international standards. Framery provides additional safety measurements to adhere to local regulatory requirements.

**Seismic safety** Framery pods comply with seismic testing in accordance with ASCE 7-16 and are designed for easy floor anchoring.

## SHIPPING CRATE

**DIMENSIONS** 89.8 x 33.1 x 52 in / 228 x 84 x 132 cm.

**WEIGHT** 1102.3 lb / 500 kg Crates can be stacked (max 2 crates).

## DIMENSIONS / POWER CORD SPECIFICATIONS

Total power cord length: 23 ft (7 m)  
When installed from the roof: 12.3 ft (3.75 m)  
When installed from the base: 19.4 ft (5.9 m)

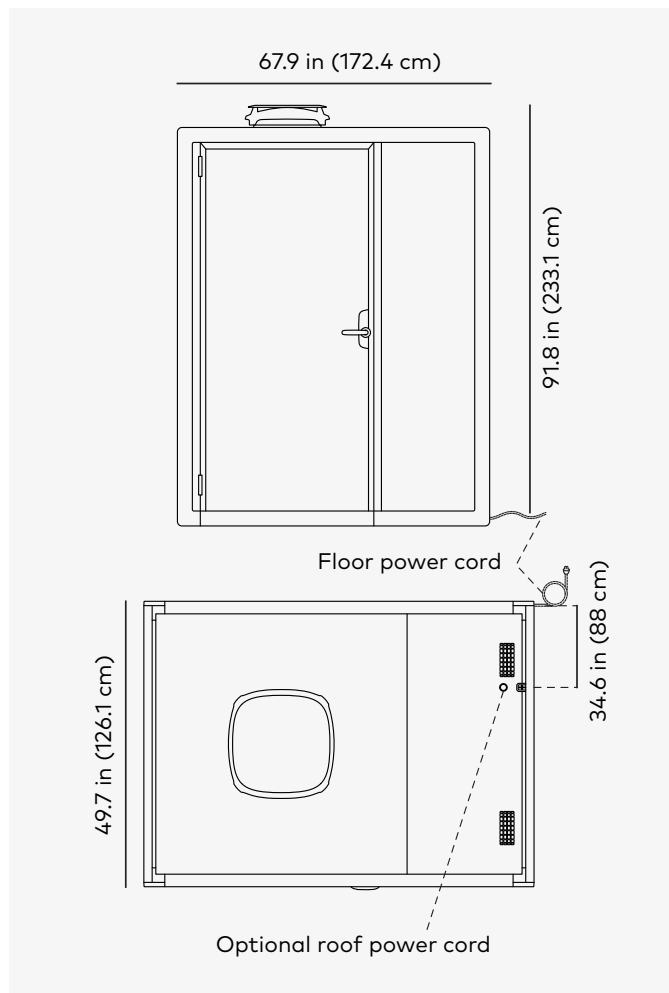

See all pod dimensions.



For the doers,  
leaders, thinkers,  
dreamers, creators,  
teams, pioneers  
and innovators.

**For people who  
get it done.**